

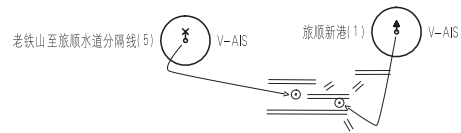

图号：12002	通告项号：2026-677
版时：2020.06	前次项号：2026-621

121-00-00E



38-45-00N



图号：12002	通告项号：2026-677
版时：2020.06	前次项号：2026-621

121-00-00E

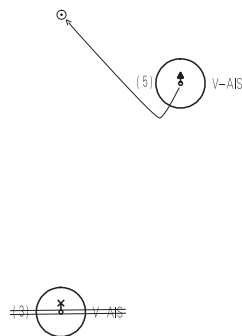

38-30-00N



图号：12003	通告项号：2026-677
版时：2017.03	前次项号：2026-469

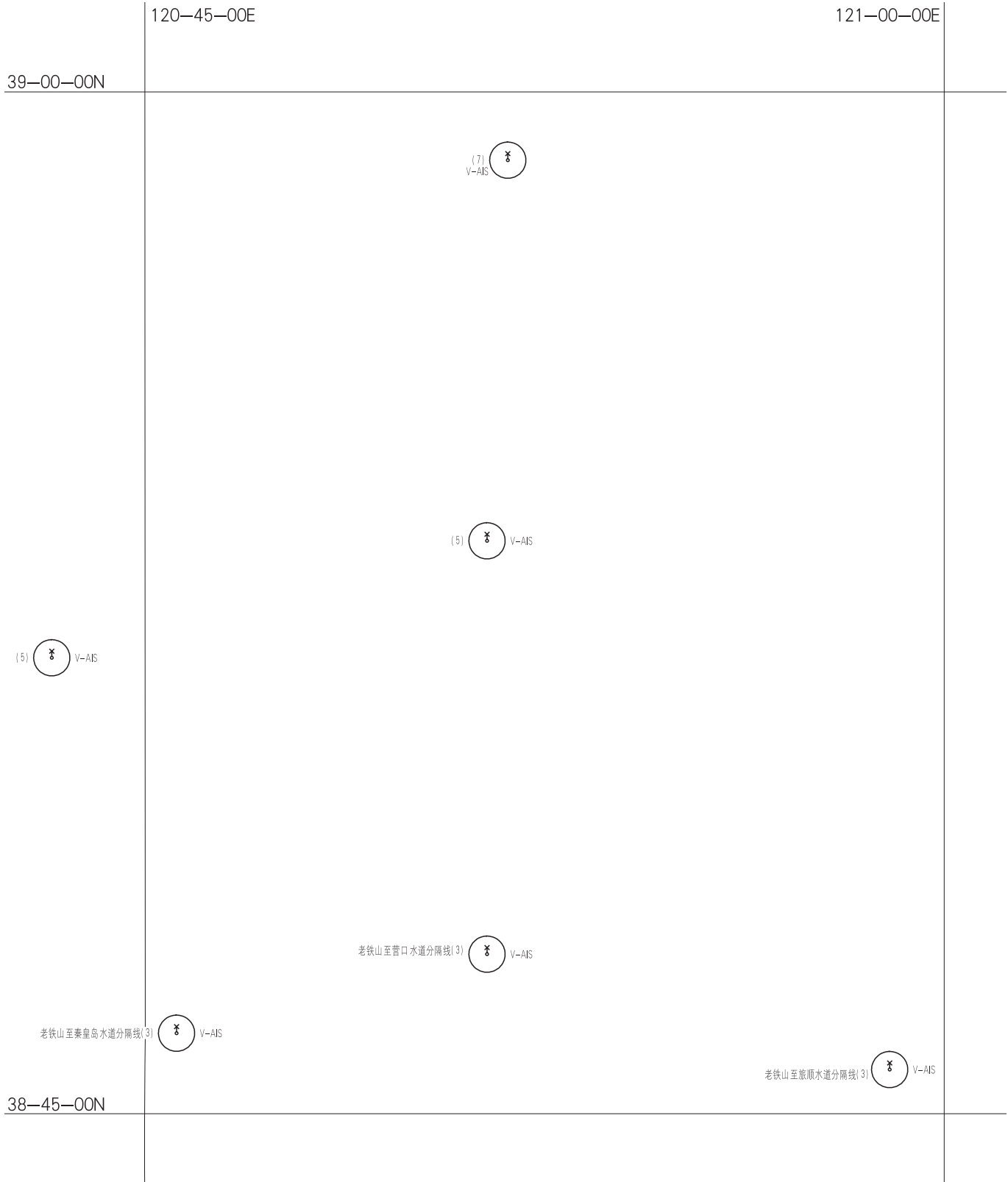



图号：12003	通告项号：2026-677
版时：2017.03	前次项号：2026-469

121-00-00E

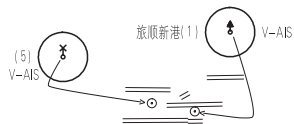

38-45-00N



图号：12004	通告项号：2026-677
版时：2022.08	前次项号：2026-472

39-00-00N

(8)  V-AIS

(7)  V-AIS

(5)  V-AIS

(3)  V-AIS  
120-45-00E



图号：12004	通告项号：2026-677
版时：2022.08	前次项号：2026-472

39-00-00N

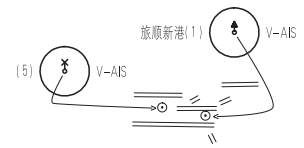

121-00-00E



图号：12004	通告项号：2026-677
版时：2022.08	前次项号：2026-472

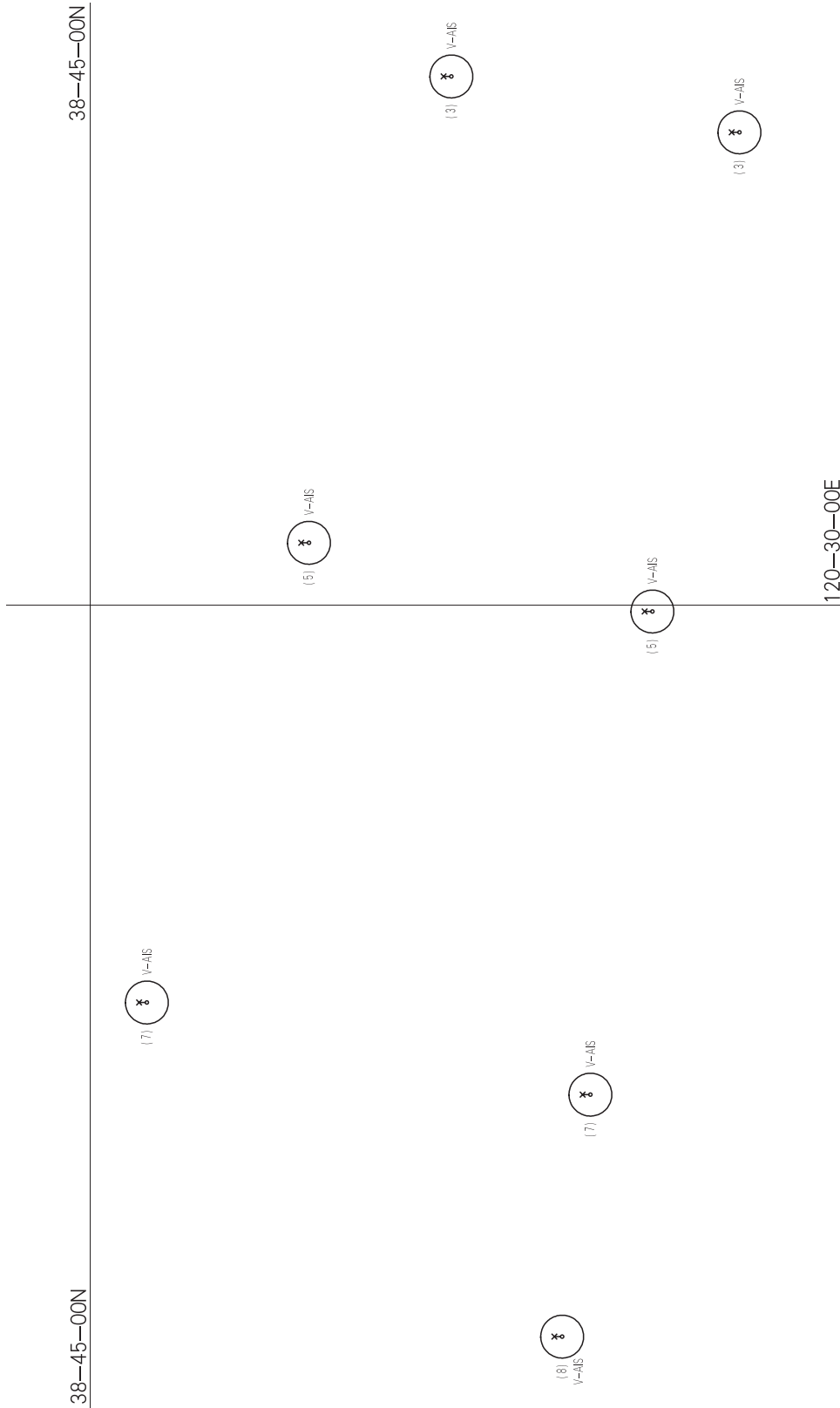



图号：12004	通告项号：2026-677
版时：2022.08	前次项号：2026-472

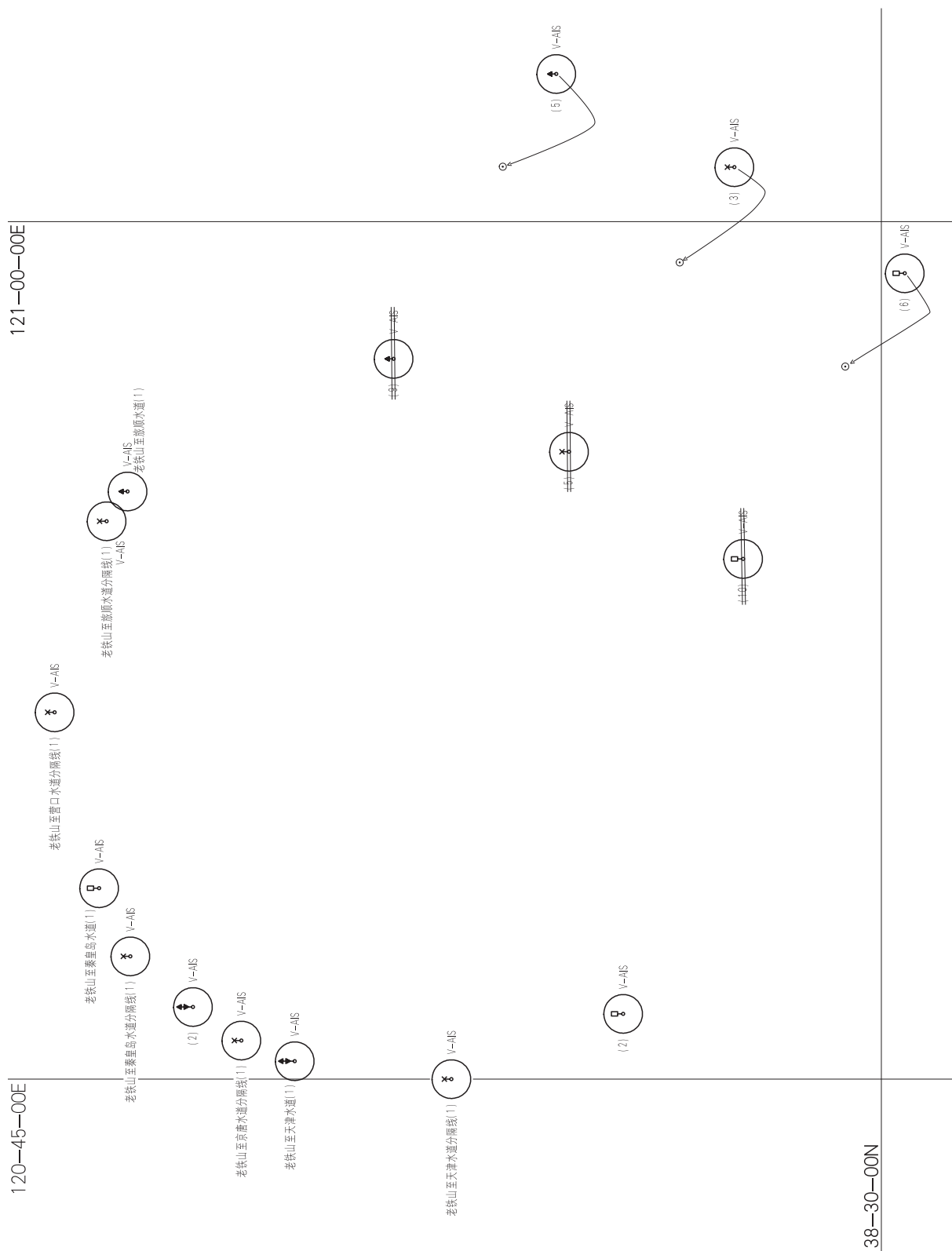



图号：12005	通告项号：2026 - 677
版时：2023.12	前次项号：2026 - 472

39-00-00N

(8)  V-AIS

(7)  V-AIS

(5)  V-AIS

120-45-00E | (3)  V-AIS



图号：12005	通告项号：2026-677
版时：2023.12	前次项号：2026-472

39-00-00N

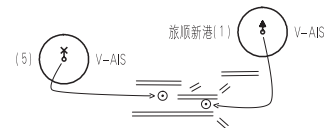

121-00-00E



图号：12005	通告项号：2026-677
版时：2023.12	前次项号：2026-472

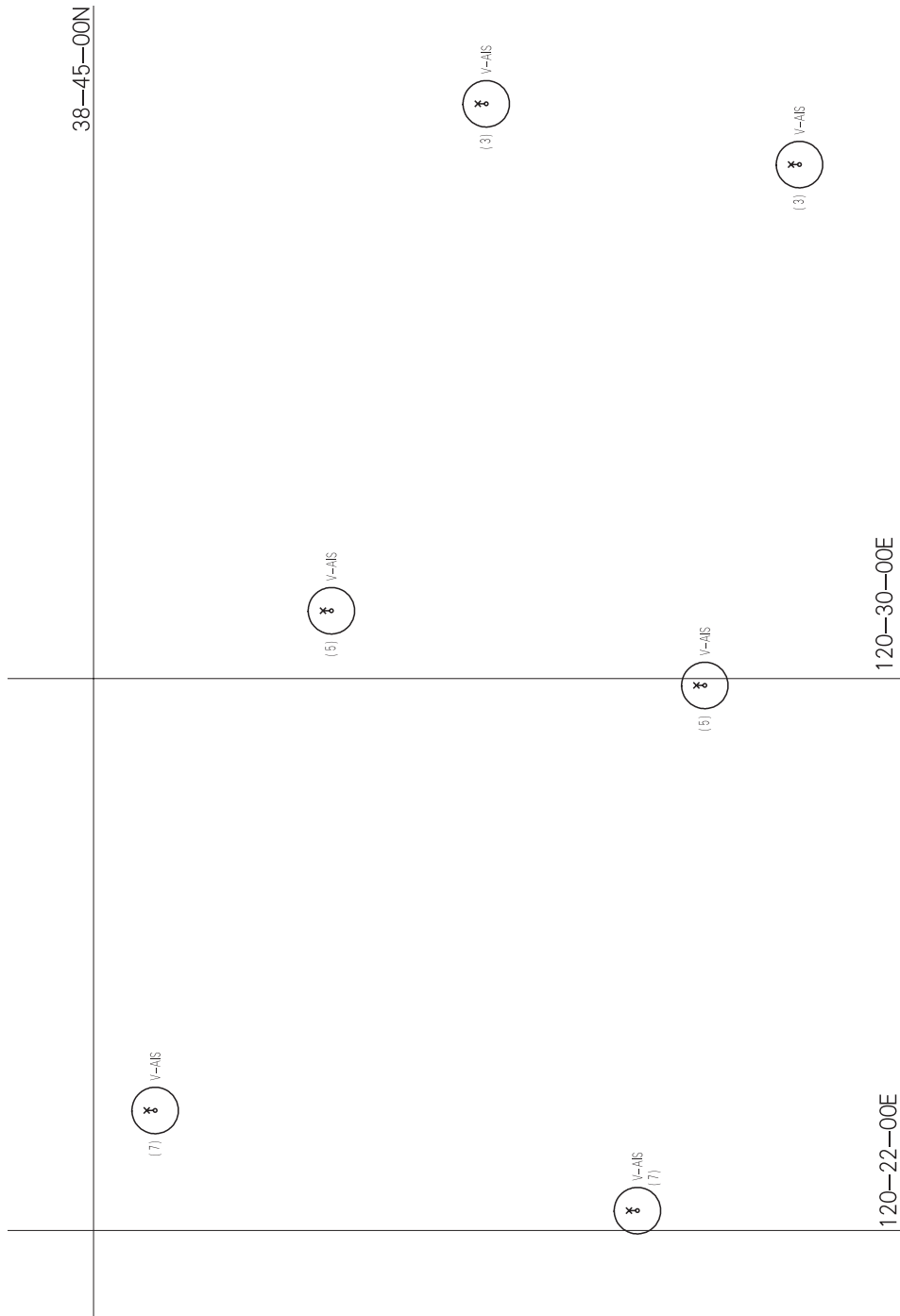



图号：12005	通告项号：2026-677
版时：2023.12	前次项号：2026-472

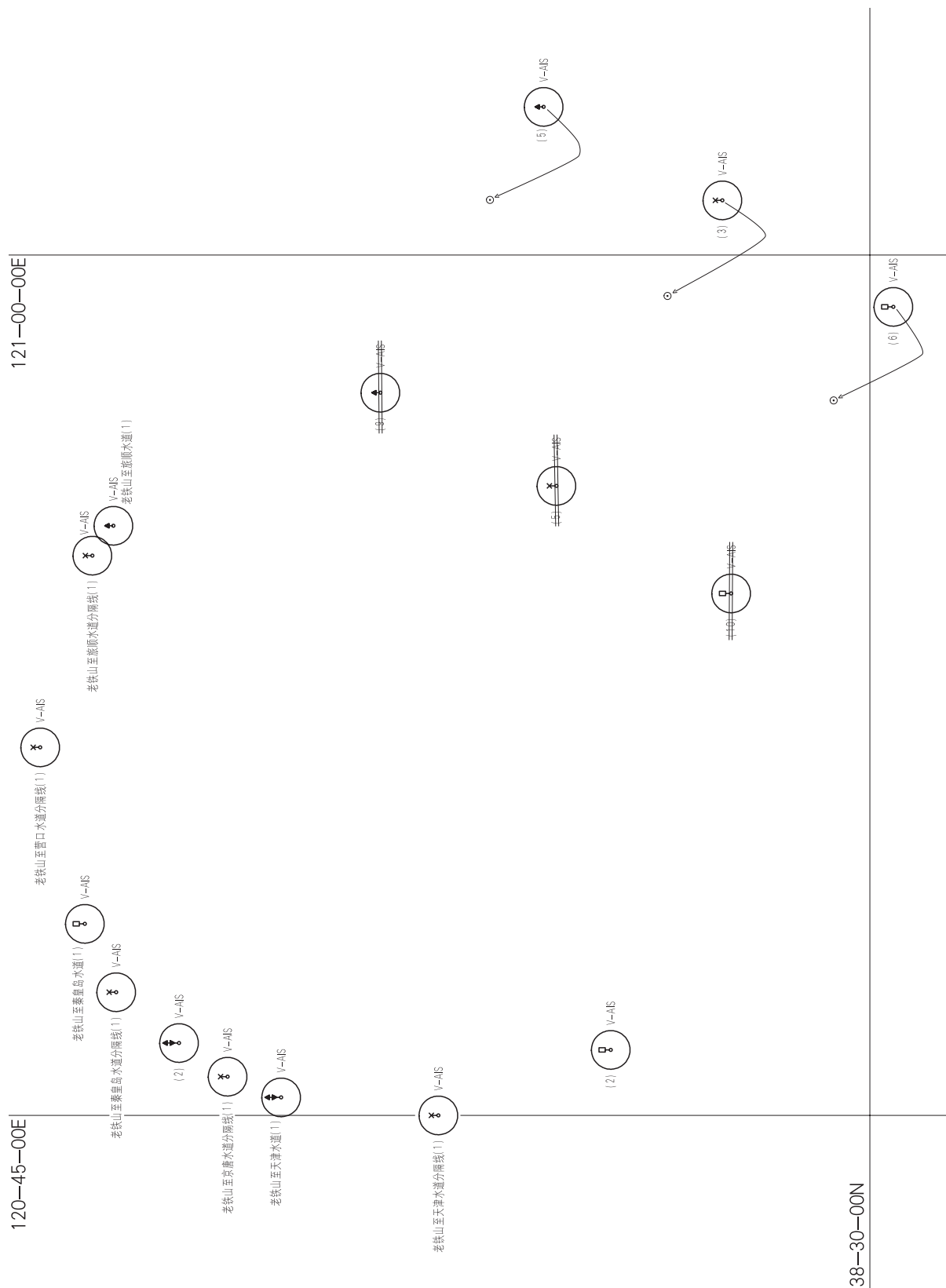



图号：12338	通告项号：2026-677
版时：2019.03	前次项号：2026-472

120-50-00E



38-45-00N





图号：12338	通告项号：2026 - 677
版时：2019.03	前次项号：2026 - 472

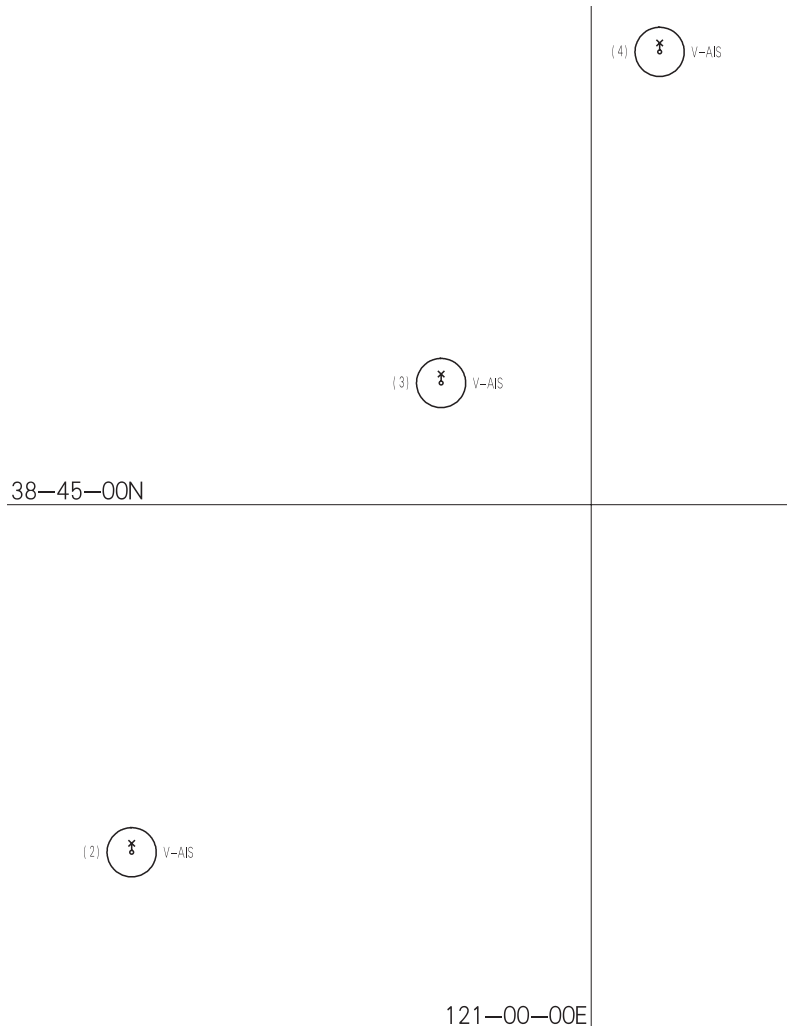



图号：12338	通告项号：2026-677
版时：2019.03	前次项号：2026-472

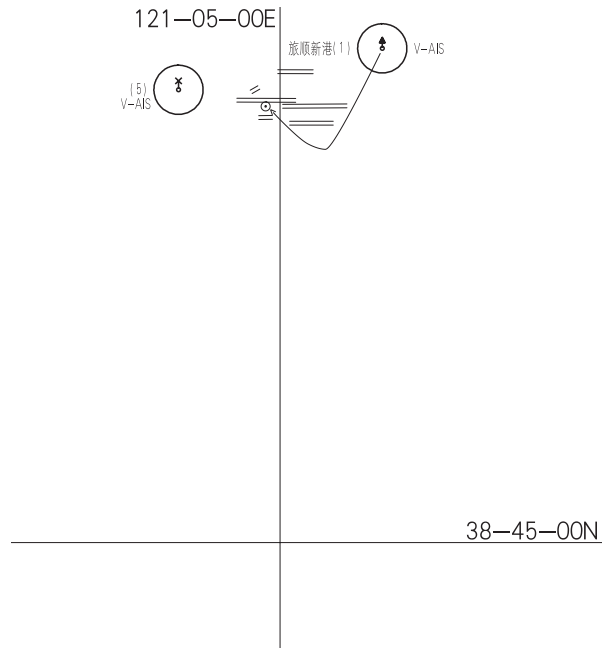



图号：12338	通告项号：2026-677
版时：2019.03	前次项号：2026-472

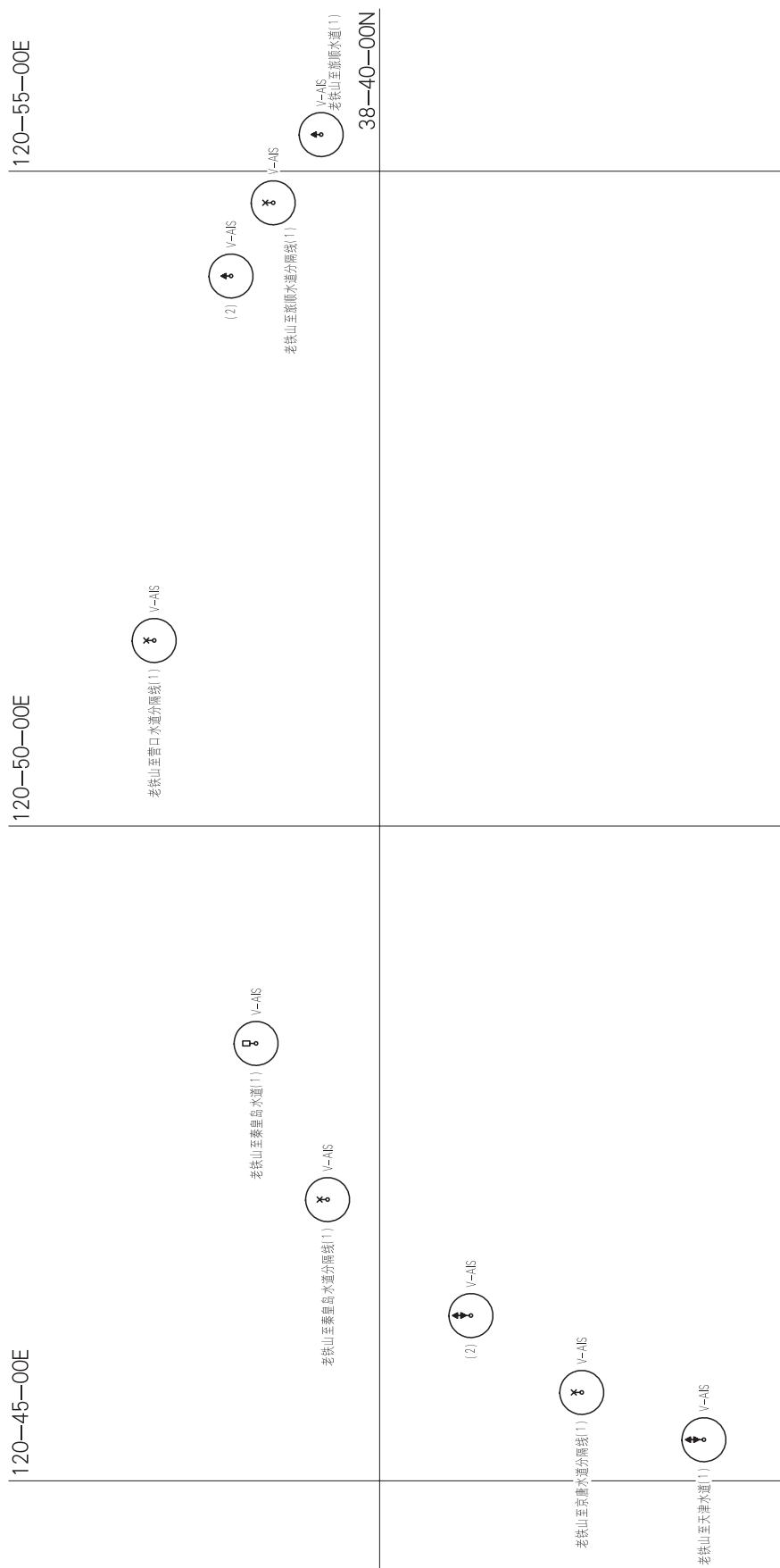



图号：12338	通告项号：2026-677
版时：2019.03	前次项号：2026-472

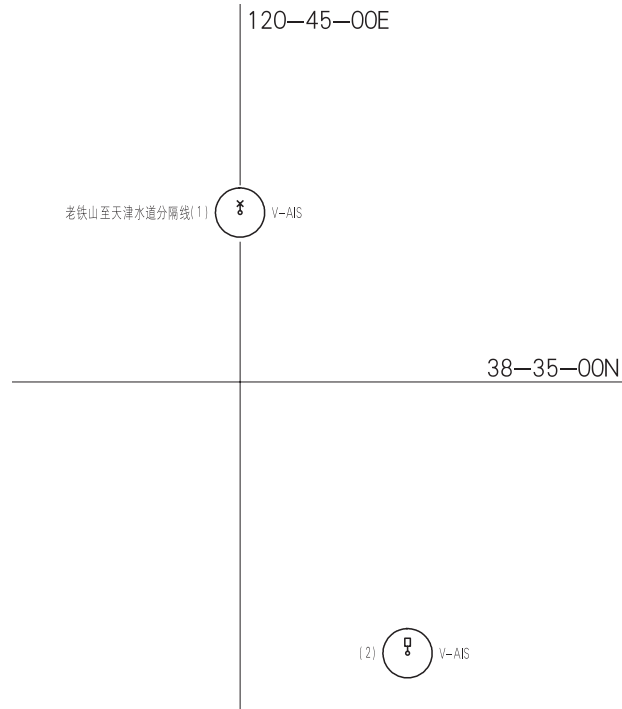



图号：12338	通告项号：2026-677
版时：2019.03	前次项号：2026-472

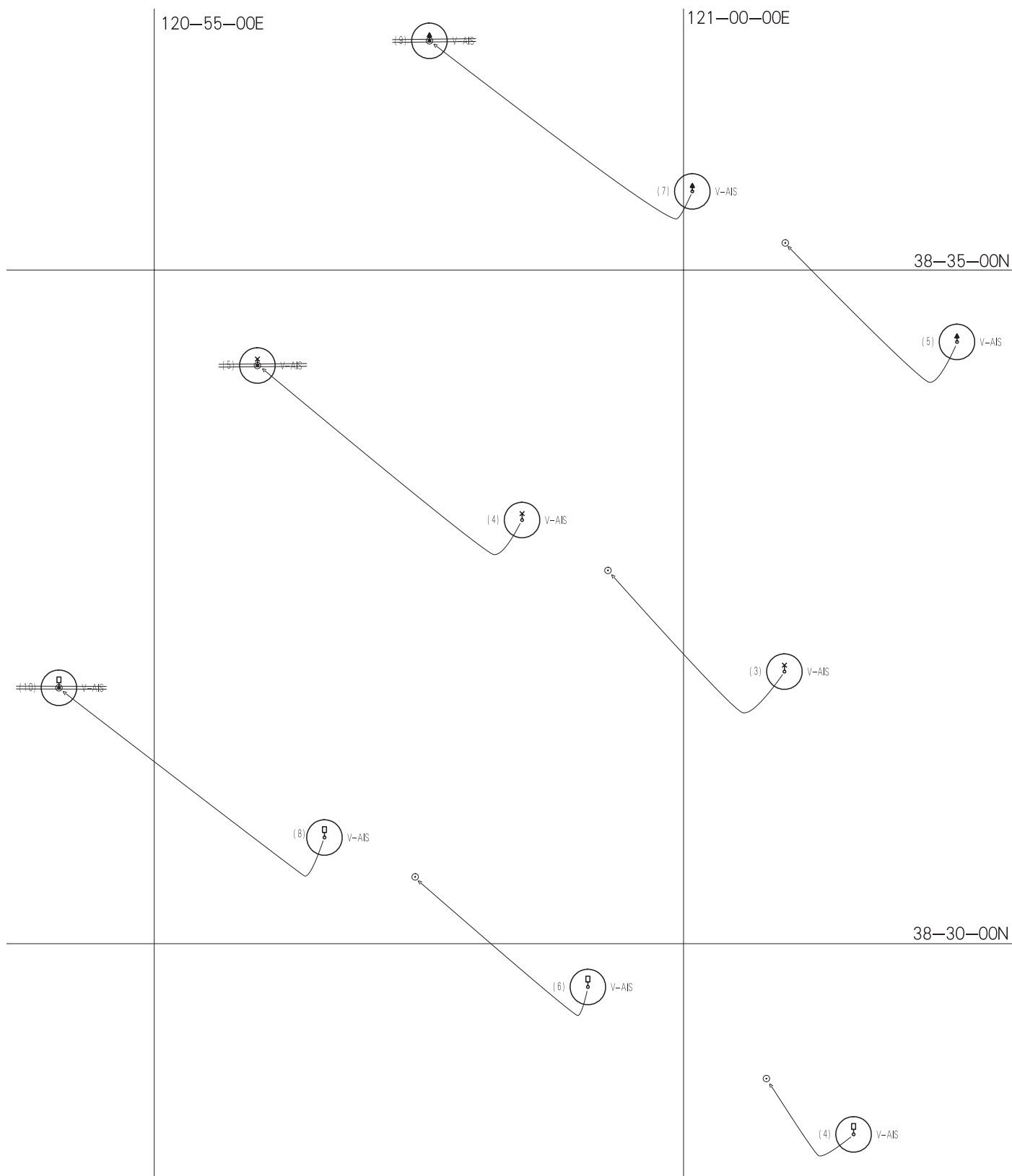



图号：12338	通告项号：2026-677
版时：2019.03	前次项号：2026-472

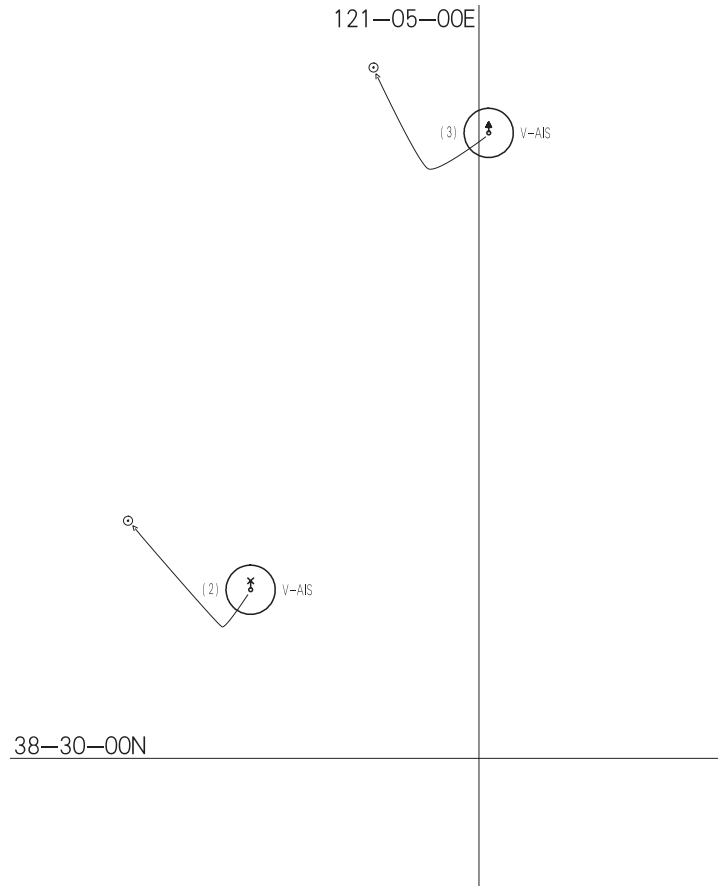



图号：12344	通告项号：2026-677
版时：2024.01	前次项号：2026-469

38-51-00N

(4)  V-AIS

120-51-00E



图号：12344	通告项号：2026-677
版时：2024.01	前次项号：2026-469

38-48-00N

老铁山至营口水道分隔线(3)  V-AIS

120-51-00E



图号：12344	通告项号：2026-677
版时：2024.01	前次项号：2026-469

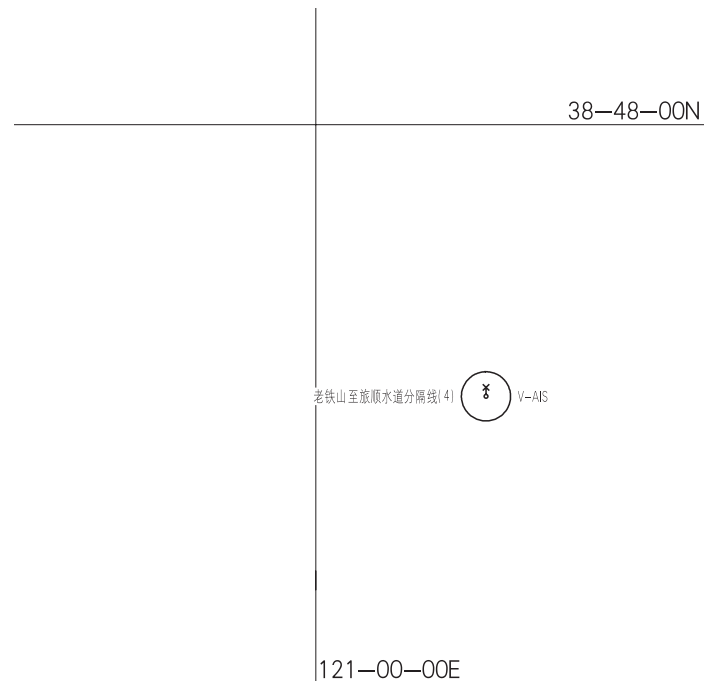

图号：12344	通告项号：2026-677
版时：2024.01	前次项号：2026-469

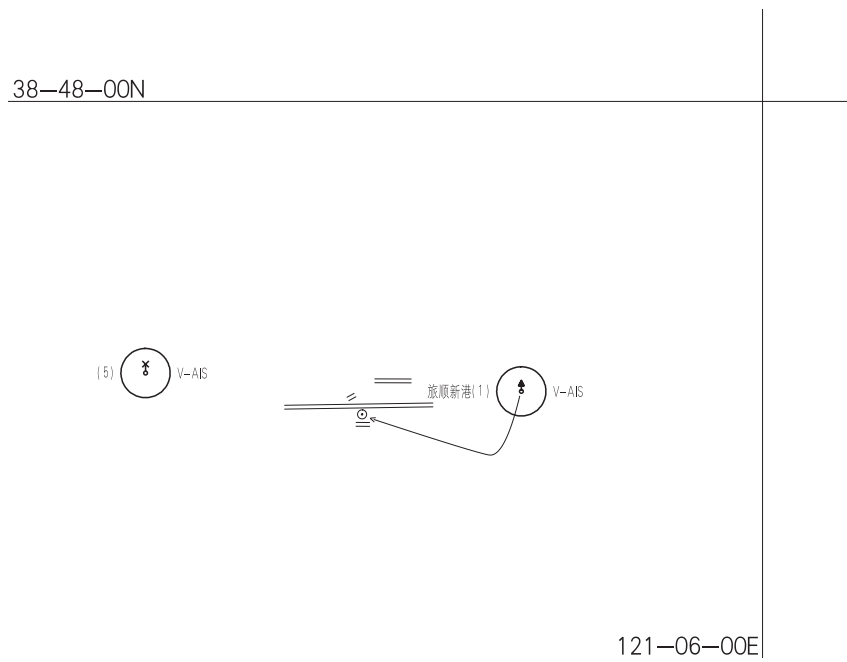



图号：12345	通告项号：2026 - 677
版时：2023.11	前次项号：2025 - 1112

121-05-00E

老铁山至旅顺水道分隔线(5)  V-AIS

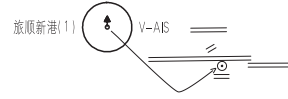

38-47-00N



图号：33001	通告项号：2026-678
版时：2020.03	前次项号：2026-620

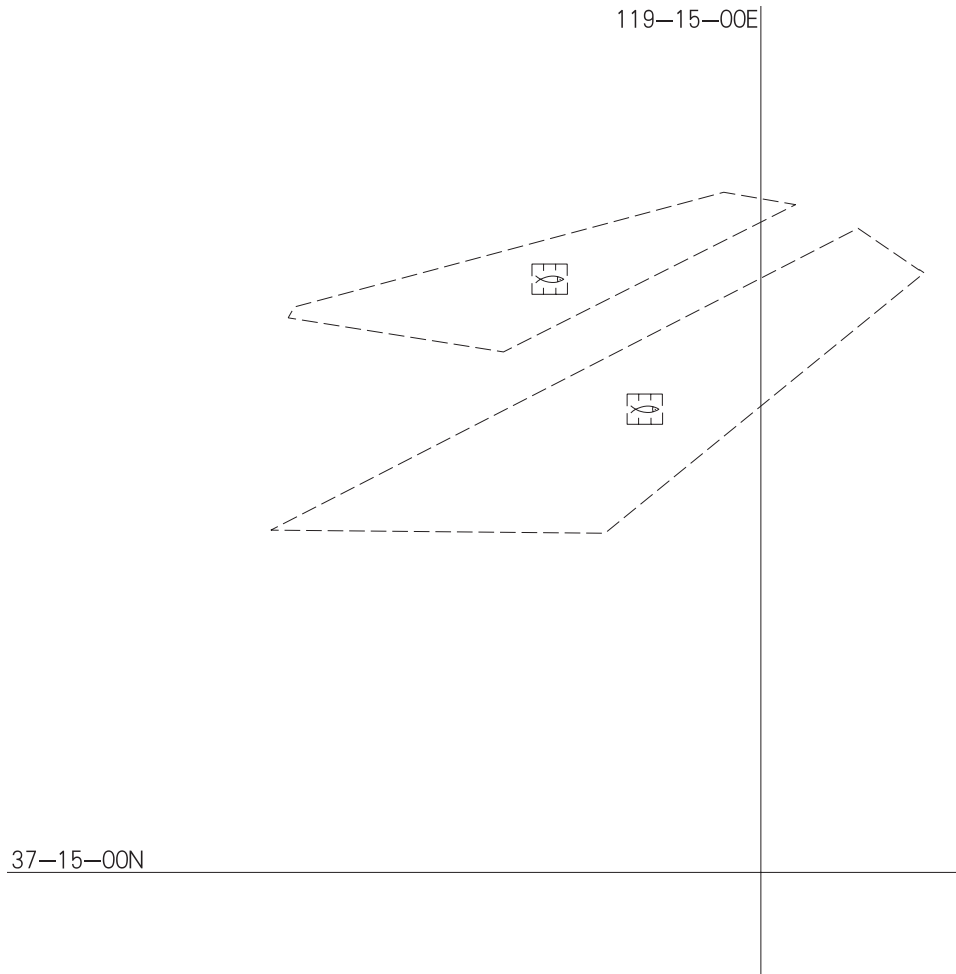



图号：33301	通告项号：2026-678
版时：2024.08	前次项号：2026-620

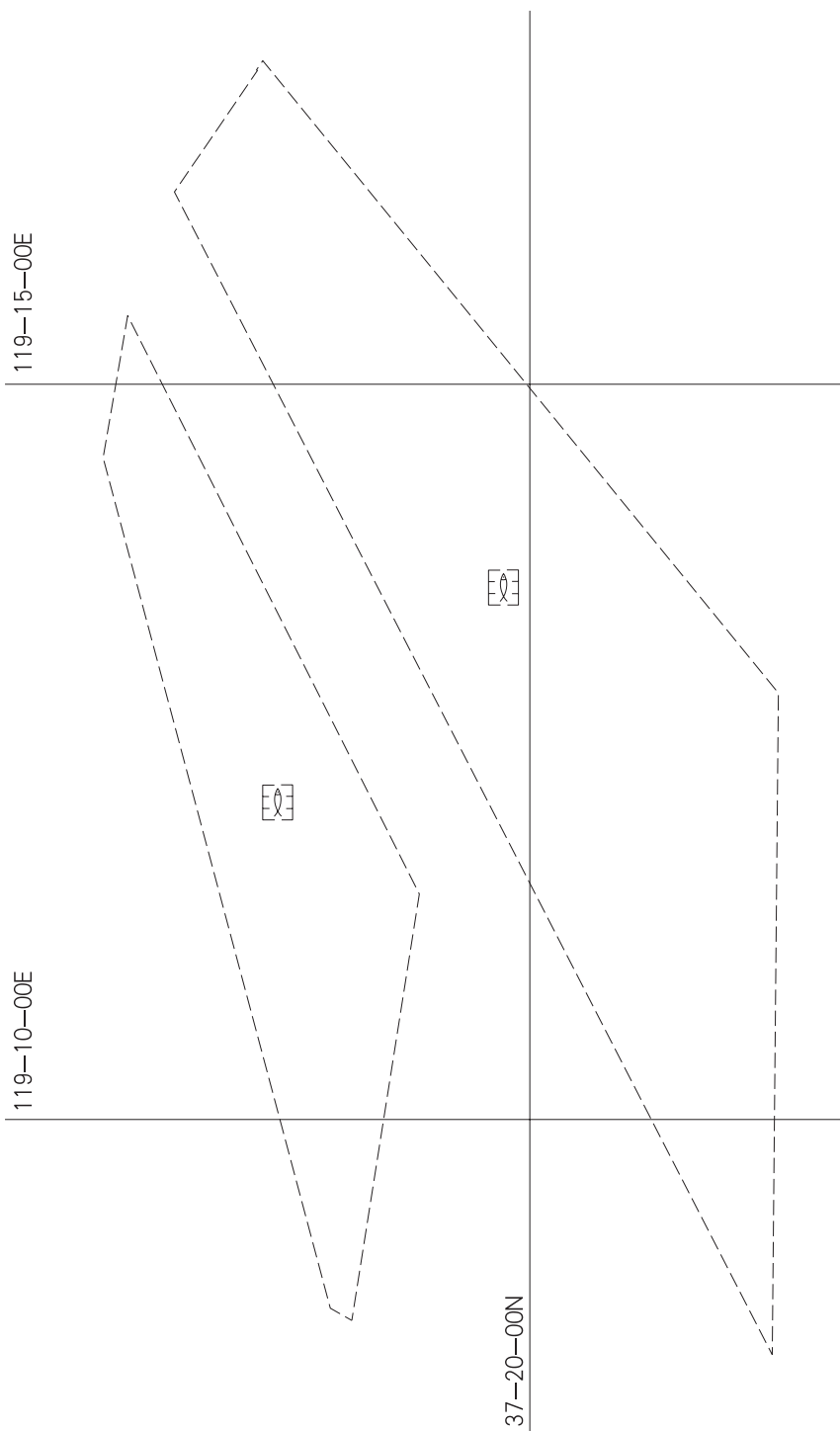



图号：33321	通告项号：2026-678
版时：2024.10	前次项号：2024-

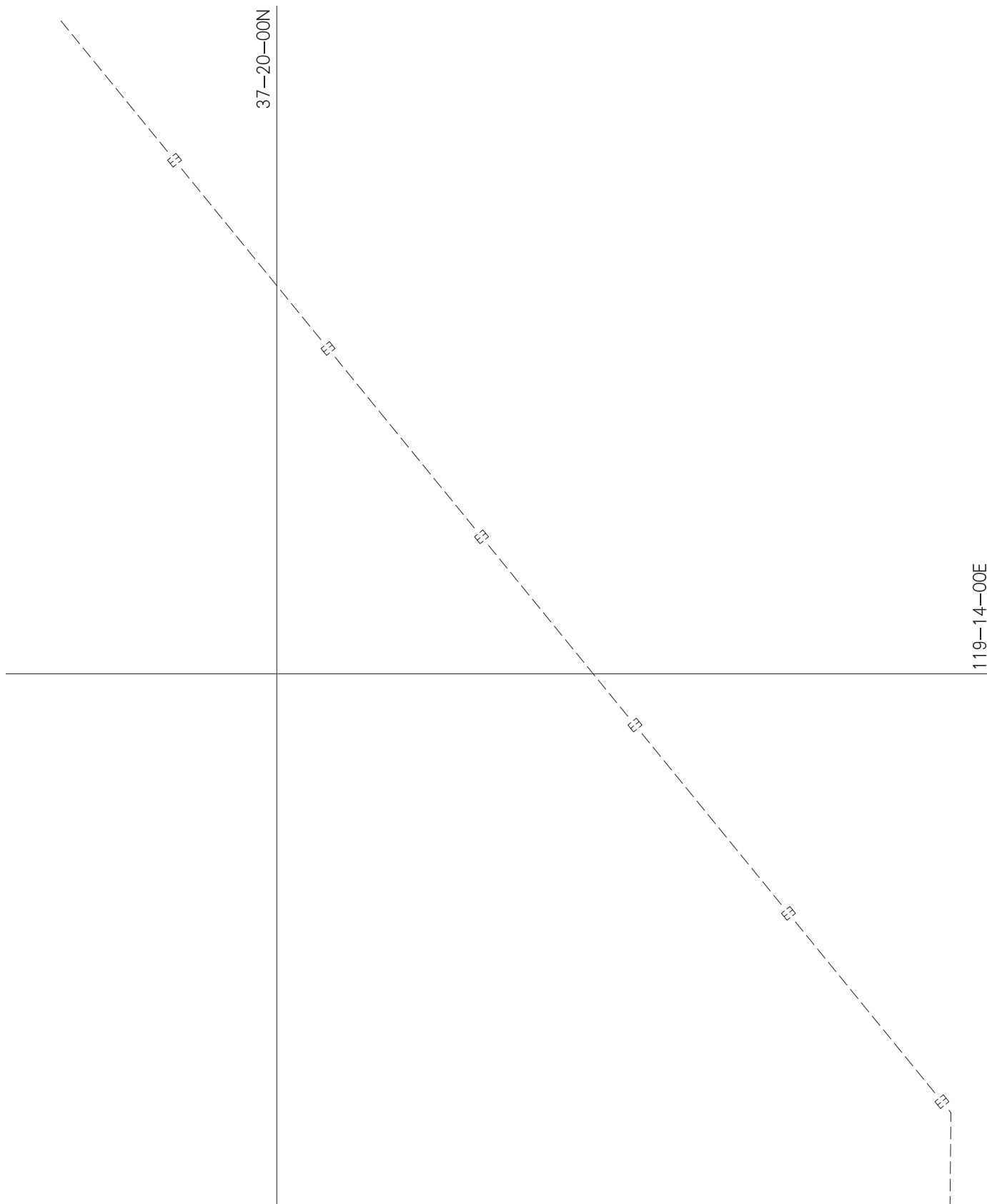



图号：33321	通告项号：2026-678
版时：2024.10	前次项号：2024-

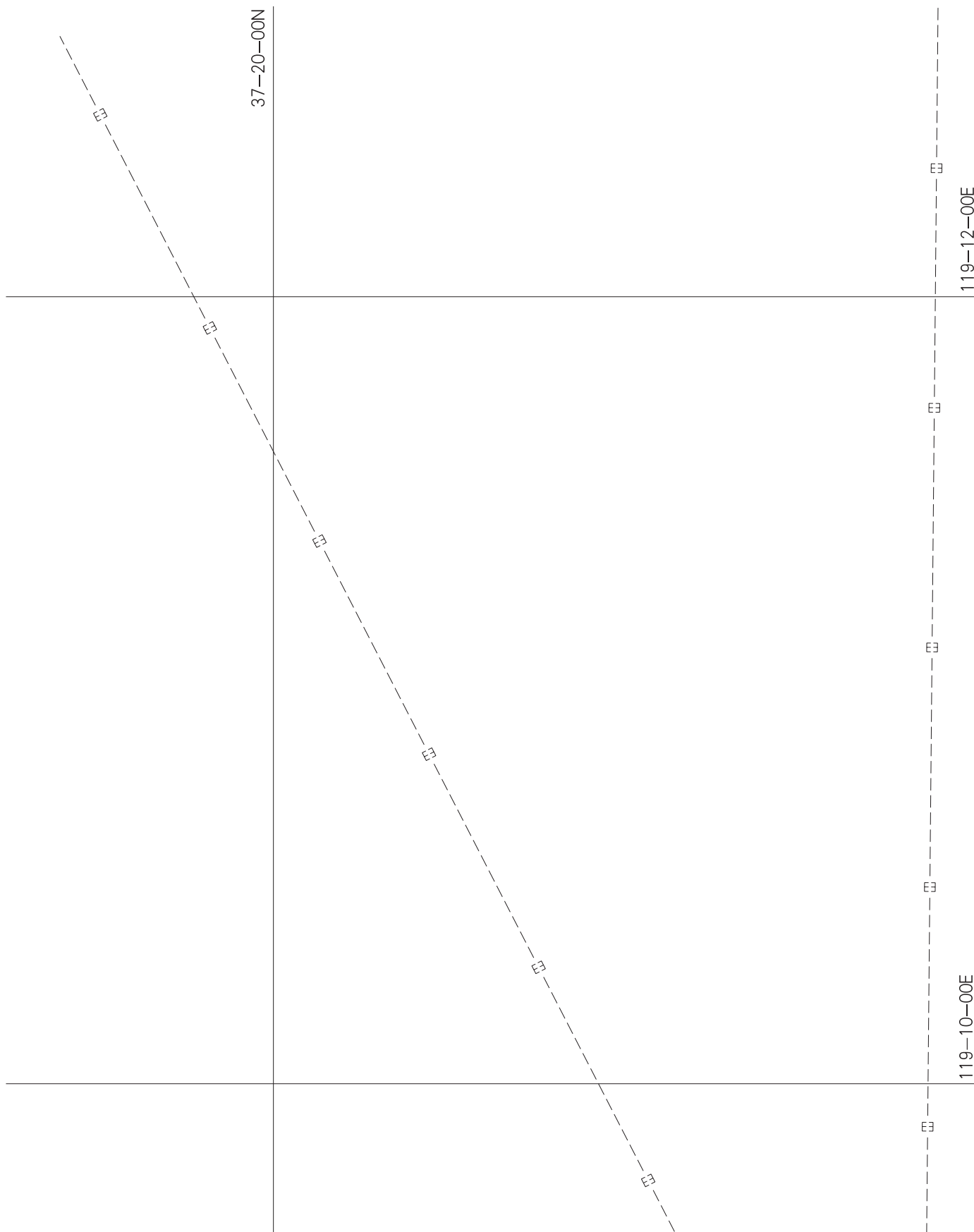



图号：33321	通告项号：2026-678
版时：2024.10	前次项号：2024-

37-20-00N

119-08-00E

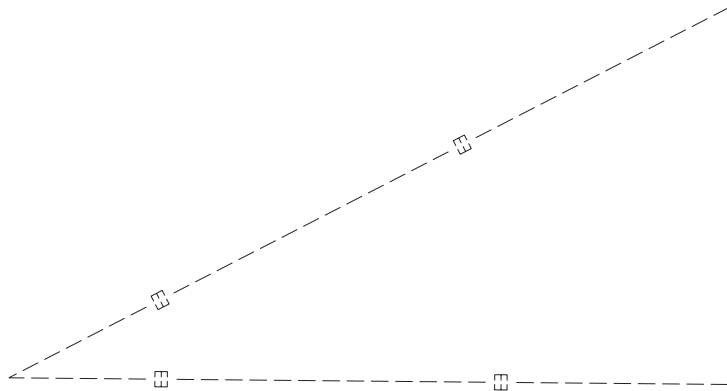



图号：33322	通告项号：2026-678
版时：2024.10	前次项号：2025-1080

37-22-00N

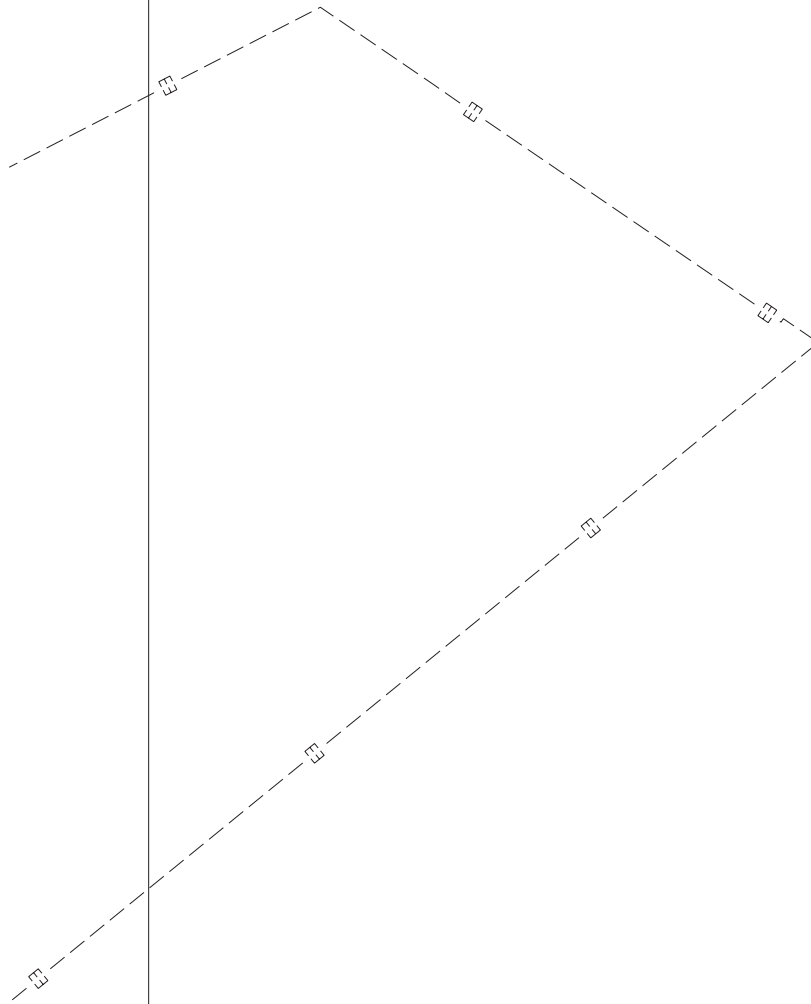

119-16-00E



图号：33324	通告项号：2026-678
版时：2025.12	前次项号：2025-

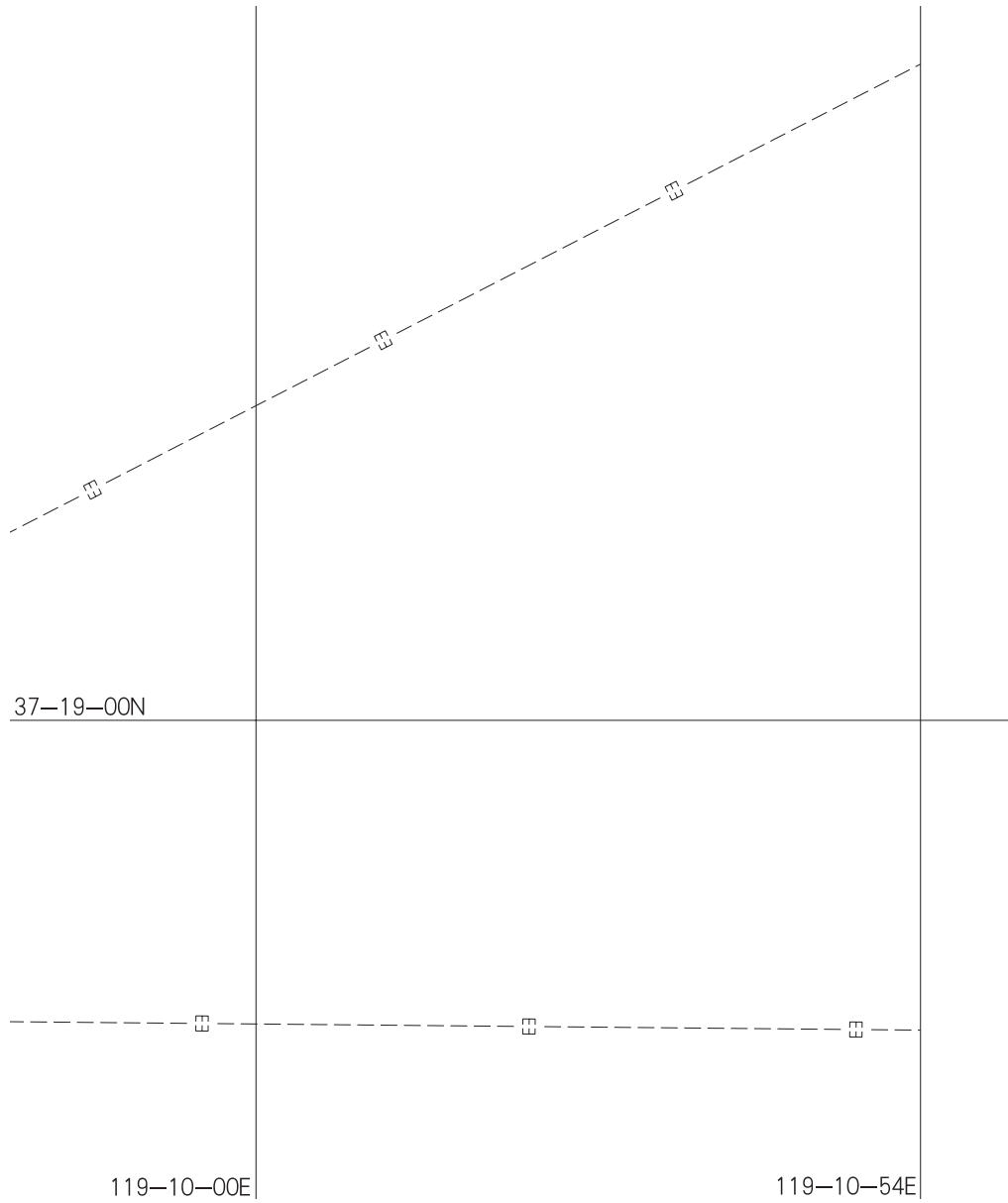



图号：33324	通告项号：2026-678
版时：2025.12	前次项号：2025-

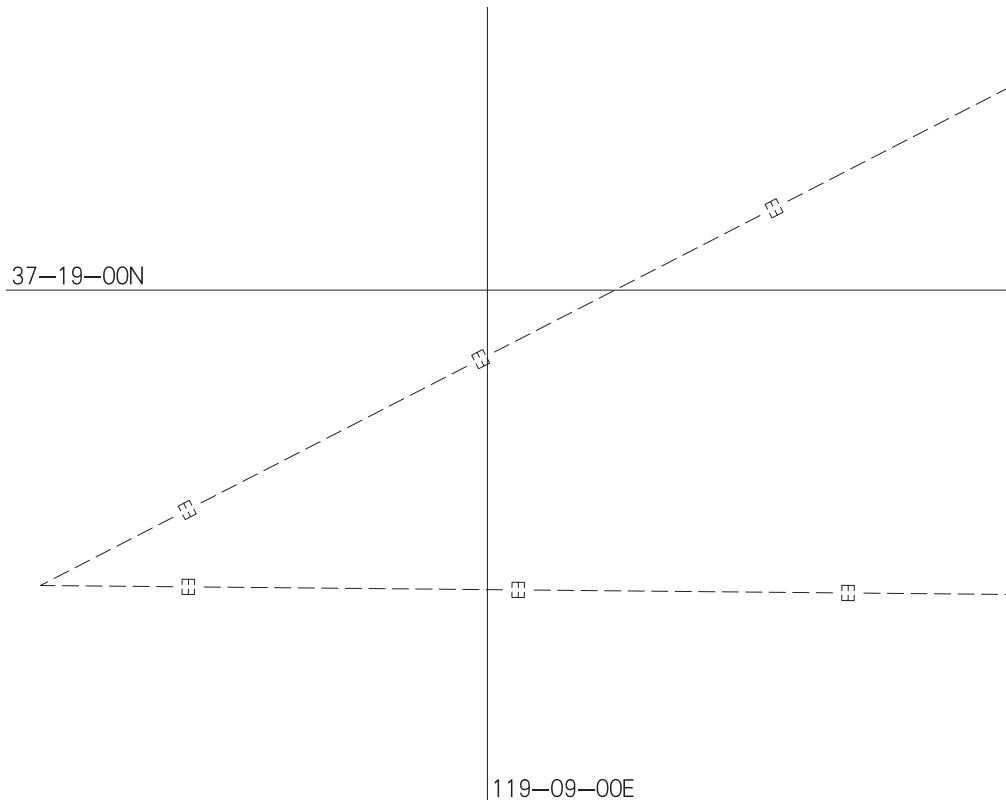



图号：33326	通告项号：2026-678
版时：2025.08	前次项号：2025-1079

37-22-00N

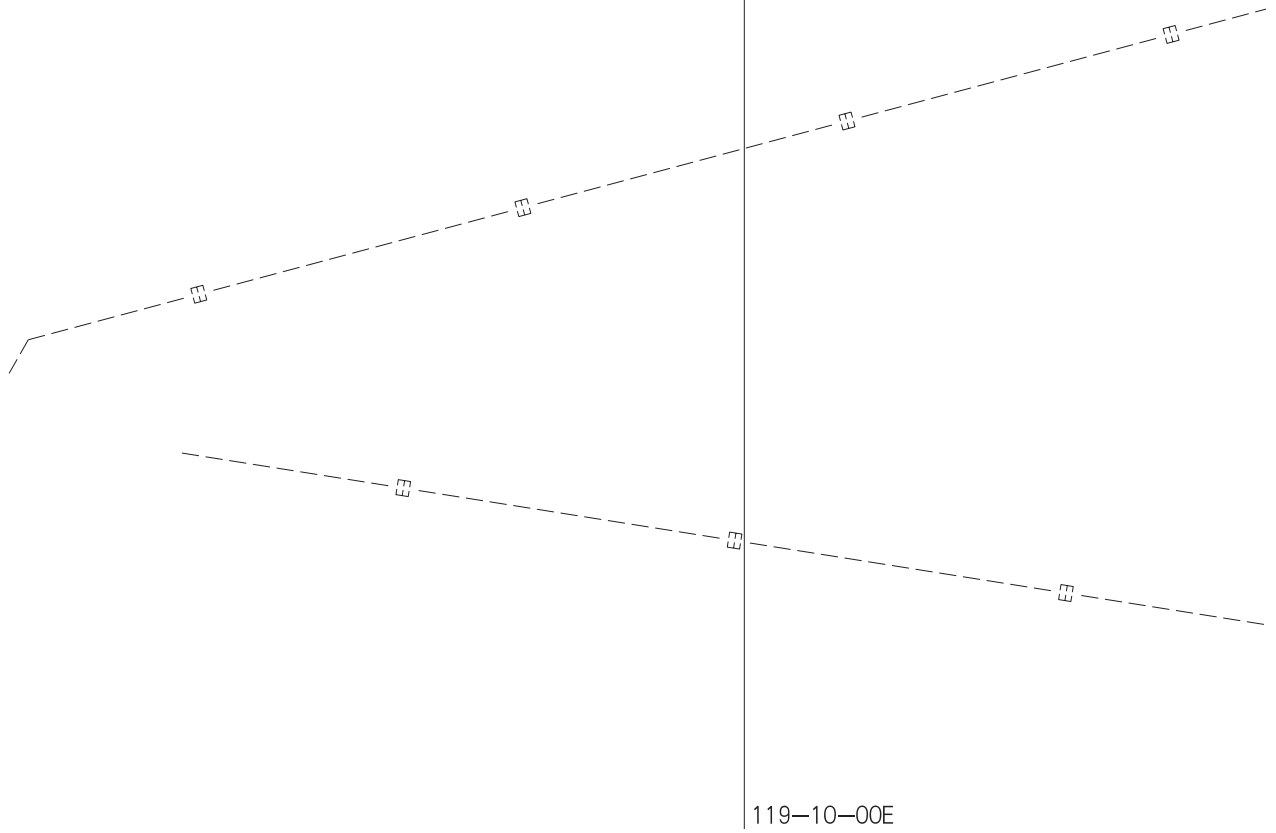



图号：33326	通告项号：2026-678
版时：2025.08	前次项号：2025-1079

37-22-00N

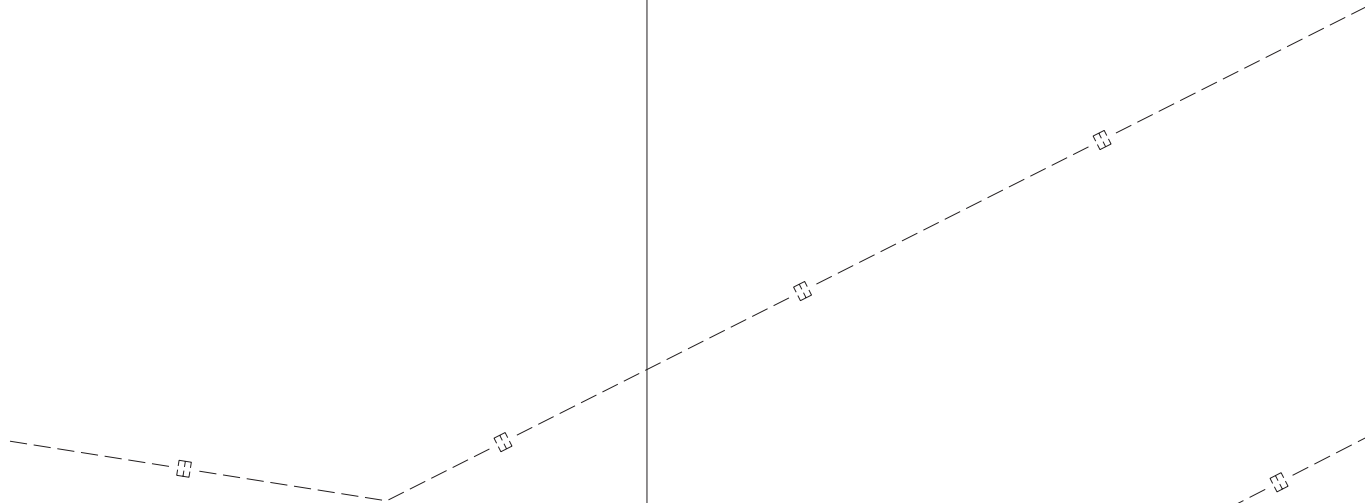
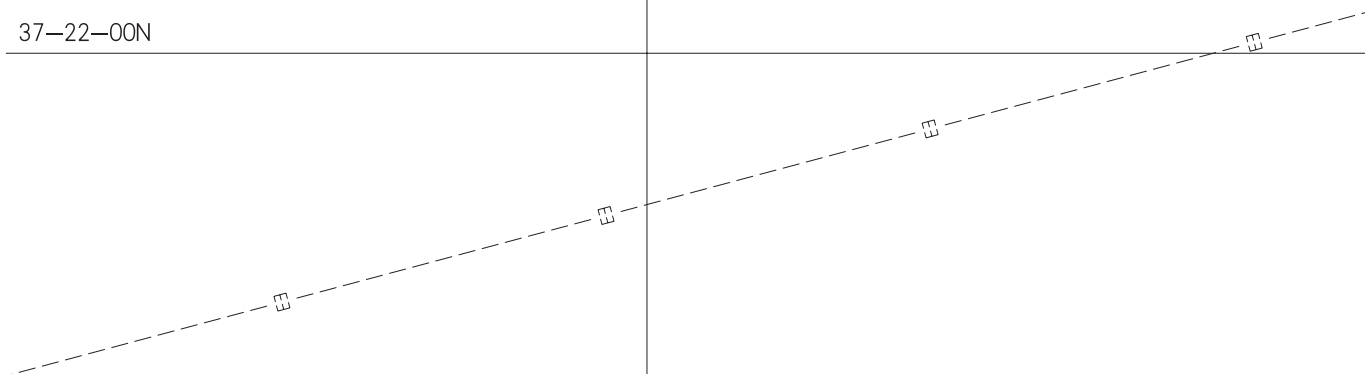

37-20-04N

119-12-00E



图号：33326	通告项号：2026-678
版时：2025.08	前次项号：2025-1079

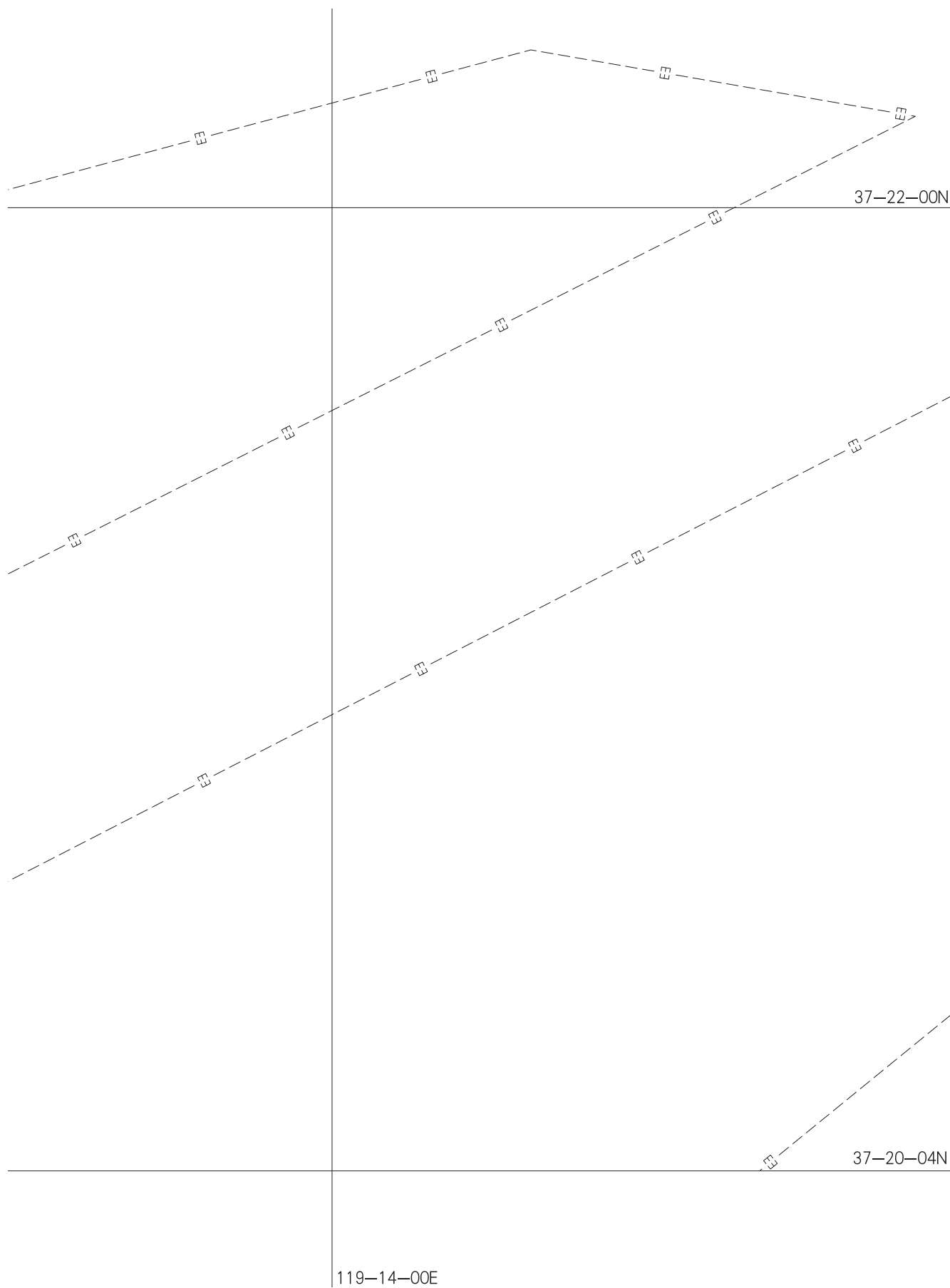



图号：33326	通告项号：2026-678
版时：2025.08	前次项号：2025-1079

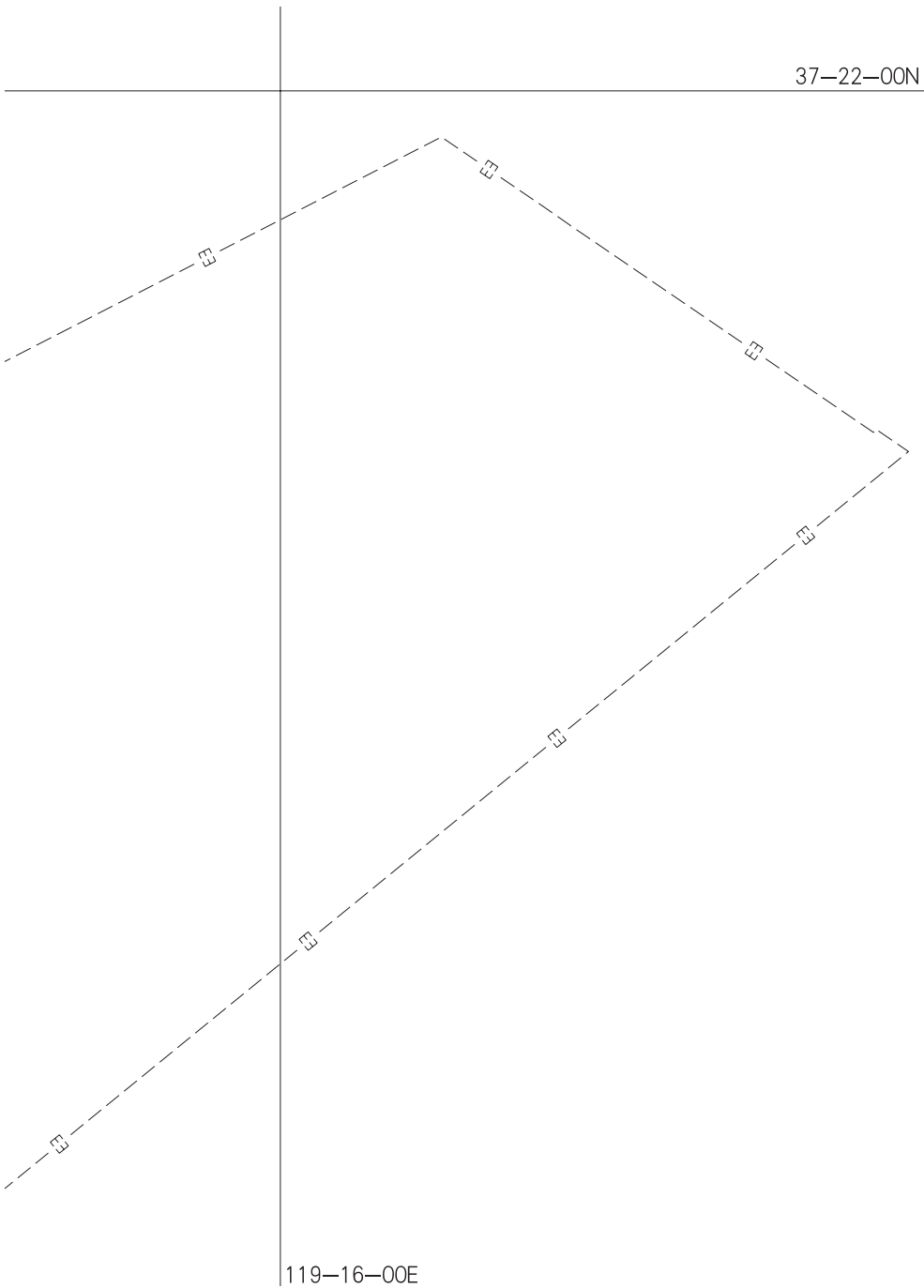



图号：36144	通告项号：2026-679
版时：2024.12	前次项号：2026-630

120-10-00E

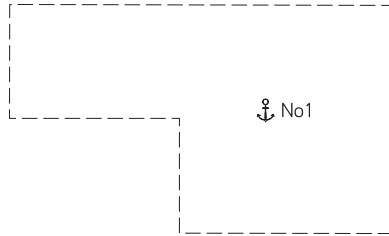

35-20-00N

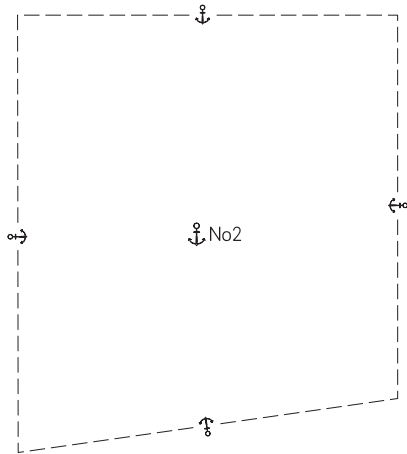



图号：37001	通告项号：2026-679
版时：2023.01	前次项号：2026-630

120-15-00E

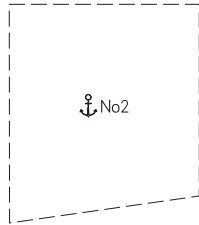
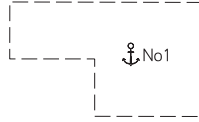

35-15-00N



图号：1301	通告项号：2026-677
版时：2016.03	前次项号：2026-472

121-00-00E

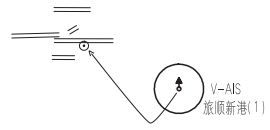

38-30-00N



图号：1302	通告项号：2026-677
版时：2016.03	前次项号：2026-621

39-00-00N



121-00-00E







图号：1306	通告项号：2026-679
版时：2012.10	前次项号：2026-635

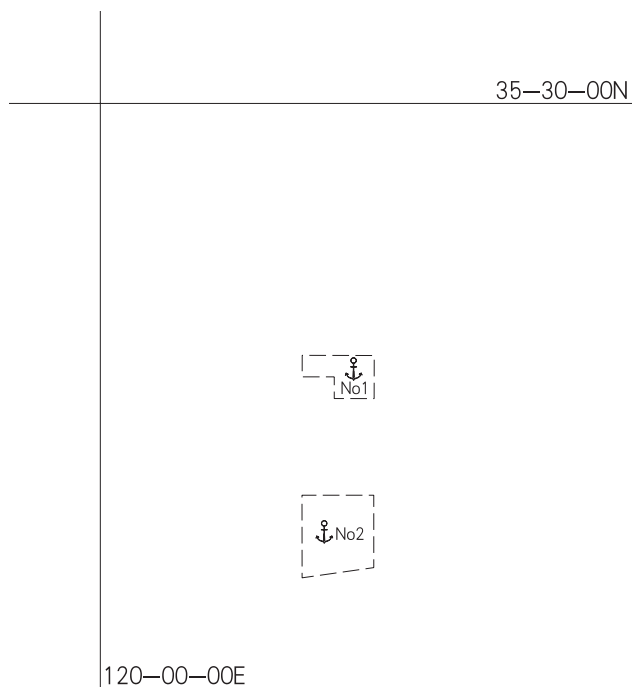

图号：1306	通告项号：2026-679
版时：2012.10	前次项号：2026-635

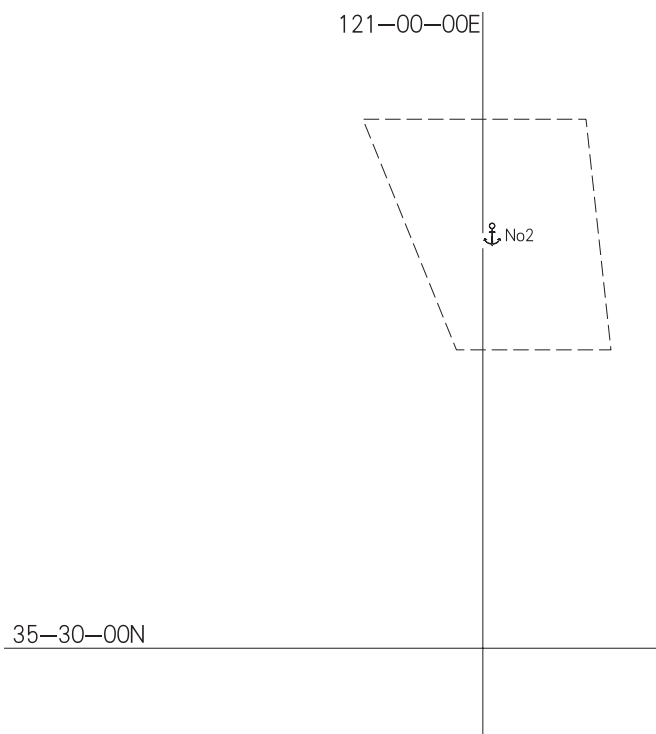



图号：44134	通告项号：2026 - 680
版时：2025.12	前次项号：2026 - 56

121-22-00E

//

31-34-00N



图号：44174	通告项号：2026 - 680
版时：2025.06	前次项号：2026 - 479

31-35-00N

//

121-20-00E



图号：84002	通告项号：2026-683
版时：2023.03	前次项号：2026-600

113-45-00E



22-30-00N



图号：84206	通告项号：2026-683
版时：2024.10	前次项号：2026-601

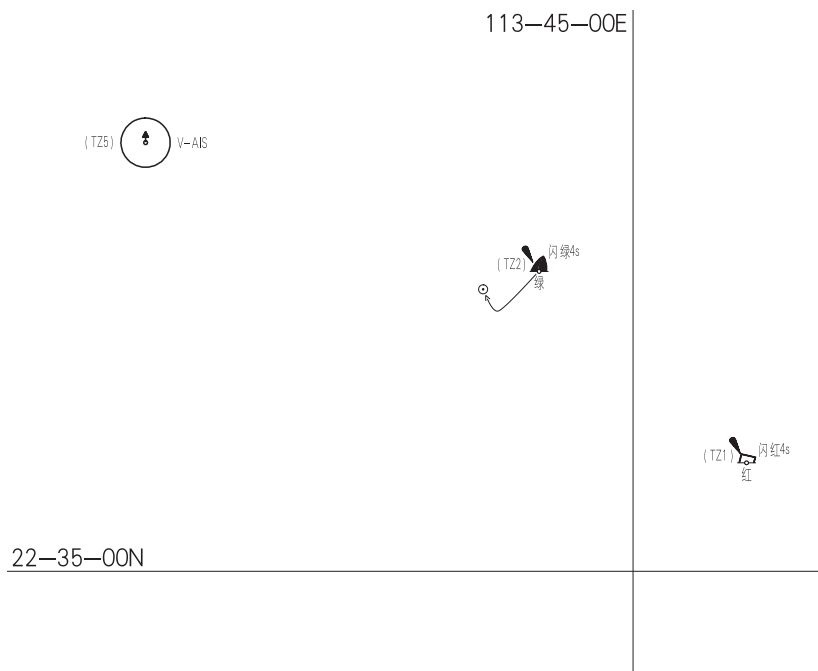

图号：84213	通告项号：2026-683
版时：2025.03	前次项号：2026-170

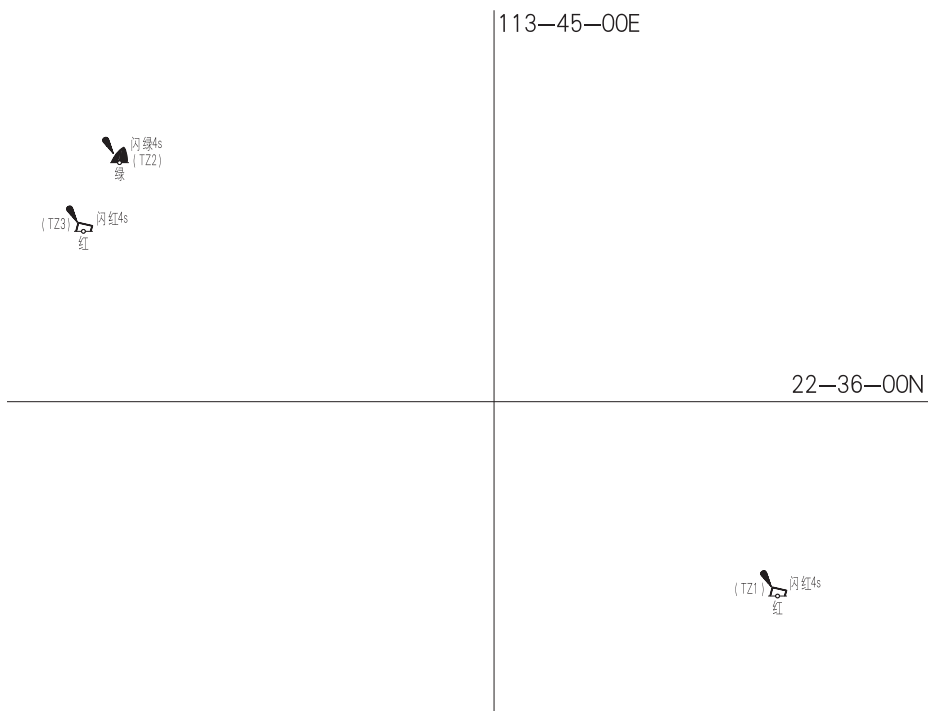



图号：84214	通告项号：2026-683
版时：2025.03	前次项号：2026-10

113-45-00E

闪绿4s  
(TZ2)  
绿

闪红4s  
(TZ3)  
红

22-36-00N

闪红4s  
(TZ1)  
红



图号：84214	通告项号：2026-683
版时：2025.03	前次项号：2026-10

113-42-00E

闪绿4s  
(TZ5)  
V-AIS

闪绿4s  
(TZ4)  
V-AIS

22-36-00N



图号：84216	通告项号：2026-684
版时：2025.03	前次项号：2026-587

22-54-00N



113-33-00E



图号：84226	通告项号：2026-683
版时：2026.01	前次项号：2026-

22-36-00N



113-46-00E



图号：84230	通告项号：2026 - 683
版时：2026.01	前次项号：2026 -

22-37-00N

(TZ2) 闪绿4s  
绿

(TZ3) 闪红4s  
红

113-44-00E



图号：84231	通告项号：2026-683
版时：2026.01	前次项号：2026-

113-42-00E



22-37-13N



图号：84234	通告项号：2026-684
版时：2026.01	前次项号：2026-

22-53-00N

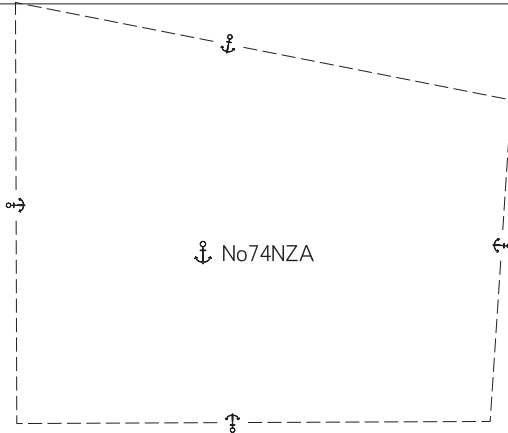

113-34-00E



图号：88103	通告项号：2026-686
版时：2026.02	前次项号：2026-559

110-24-00E

湛江军博园(1) 快红  
红

(4) 闪绿4s  
绿

21-15-00N



图号：88108	通告项号：2026-686
版时：2025.12	前次项号：2025-

110-25-00E

湛江军博园(1) 快红  
红

(3) 快红  
红  
(2) 快绿  
绿

(5) 闪红4s  
红  
(4) 闪绿4s  
绿

21-16-00N



图号：91001	通告项号：2026-687
版时：2025.07	前次项号：2026-400

21-30-00N

★  
123389.1mSM

109-30-00E



图号：91001	通告项号：2026-688
版时：2025.07	前次项号：2026-687

(7) 莫(C)黄12s 同步  
黄

(6) 莫(C)黄12s 同步  
黄

(5) V-AIS

21-15-00N

109-00-00E



图号：91001	通告项号：2026-688
版时：2025.07	前次项号：2026-687

21-15-00N

(4)  V-AIS

(3)  V-AIS

(2)  莫(C) 黄12s 同步  
黄

(1)  莫(C) 黄12s 同步  
黄

109-00-00E



图号：91102	通告项号：2026-688
版时：2023.10	前次项号：2026-314

109-06-00E



21-03-00N



图号：91201	通告项号：2026-687
版时：2025.11	前次项号：2026-401

21-30-00N

109-30-00E

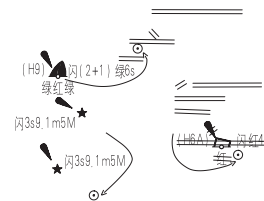

图号：91202	通告项号：2026-687
版时：2025.09	前次项号：2026-401

21-29-00N

109-32-00E

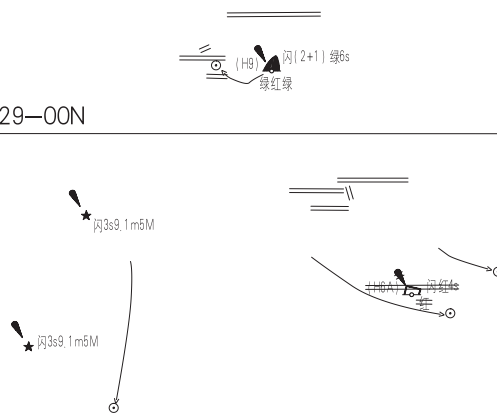



图号：91203	通告项号：2026-687
版时：2025.09	前次项号：2026-401

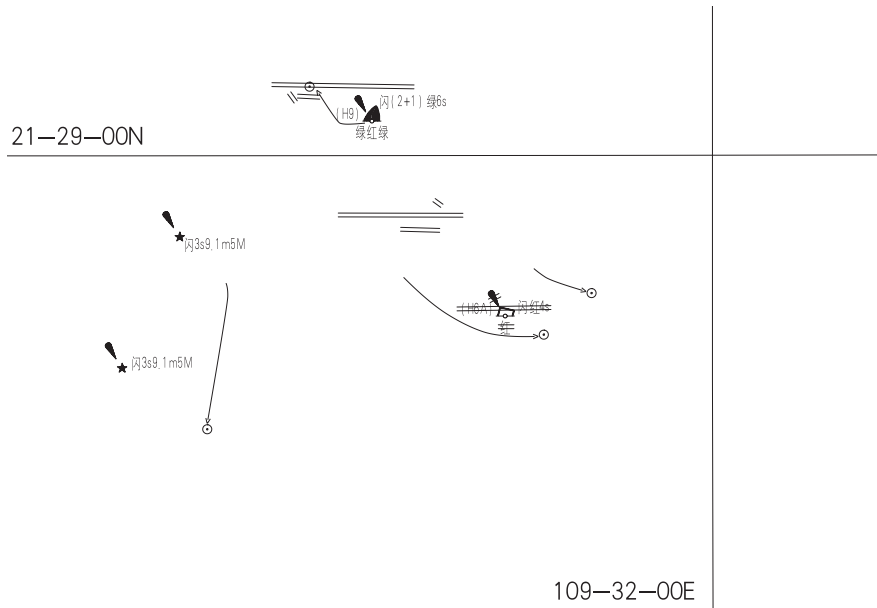

图号：91204	通告项号：2026-687
版时：2025.07	前次项号：2026-314

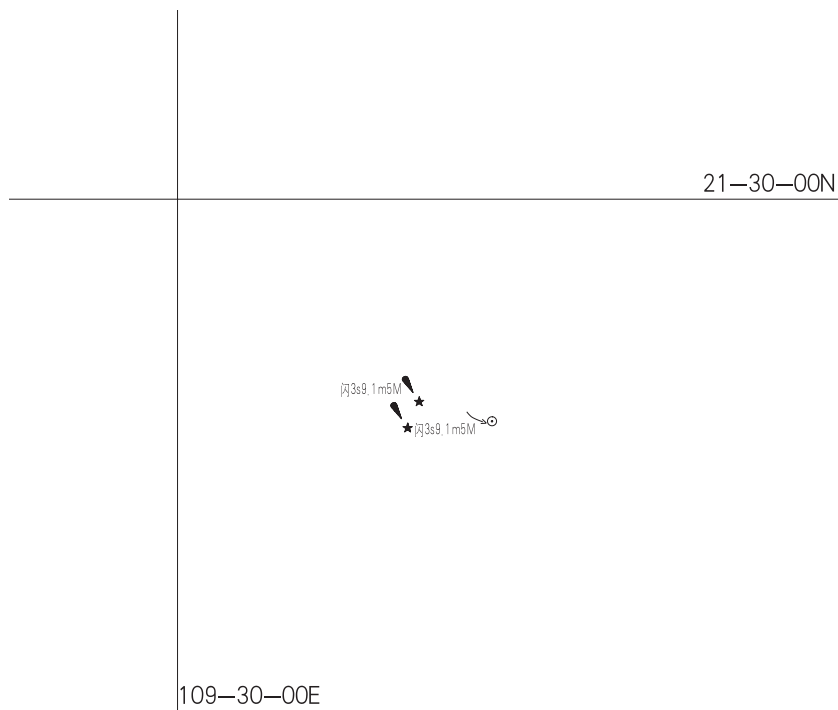



图号：91204	通告项号：2026-688
版时：2025.07	前次项号：2026-687

21-25-00N

莫(C)黄12s 同步  
(7) 黄

莫(C)黄12s 同步  
(6) 黄

109-05-00E



图号：91204	通告项号：2026-688
版时：2025.07	前次项号：2026-687

109-05-00E

(5)  V-AIS

21-15-00N

(4)  V-AIS



图号：91301	通告项号：2026 - 688
版时：2025.11	前次项号：2026 - 314

109-04-00E

莫(C) 黄12s10m4M 同步  
黄

莫(C) 黄12s 同步  
(7) 黄

21-24-00N



图号：91301	通告项号：2026-688
版时：2025.11	前次项号：2026-314

109-02-00E

莫(C)黄12s 同步  
(6)  
黄

21-20-00N



图号：92001	通告项号：2026-688
版时：2026.03	前次项号：2026-458

(7) 莫(C) 黄12s 同步  
黄

(6) 莫(C) 黄12s 同步  
黄

(5) V-AIS

21-15-00N

(4) V-AIS

109-00-00E



图号：92001	通告项号：2026 - 688
版时：2026.03	前次项号：2026 - 458

21-15-00N

(3)  V-AIS

(2)  莫(C)黄12s 同步  
黄

(1)  莫(C)黄12s 同步  
黄

109-00-00E



图号：02001	通告项号：2026 - 689
版时：2012.06	前次项号：2026 - 510

20-00-00N

网(3) 红8s29m8M

111-15-00E



图号：02501	通告项号：2026 - 690
版时：2016.01	前次项号：2025 - 504

18-40-00N

110-20-00E



图号：03001	通告项号：2026-691
版时：2012.06	前次项号：2025-504

110-15-00E

(1) 莫(F) 黄12s  
黄

(3) 莫(F) 黄12s  
黄

18-30-00N



图号：3315	通告项号：2026-689
版时：2022.03	前次项号：2026-606

20-00-00N

卷 闪(3) 6s29m8M

111-00-00E