

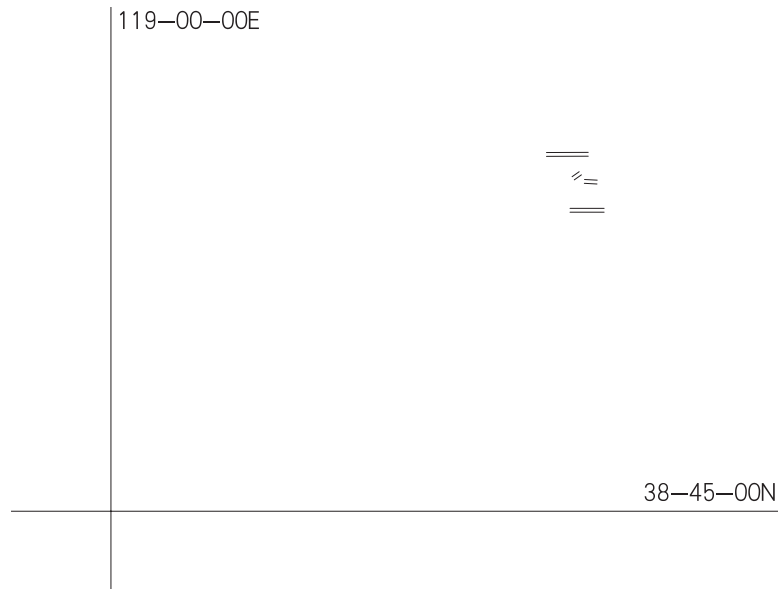

图号：22001	通告项号：2025 - 12
版时：2024.09	前次项号：2024 - 1329

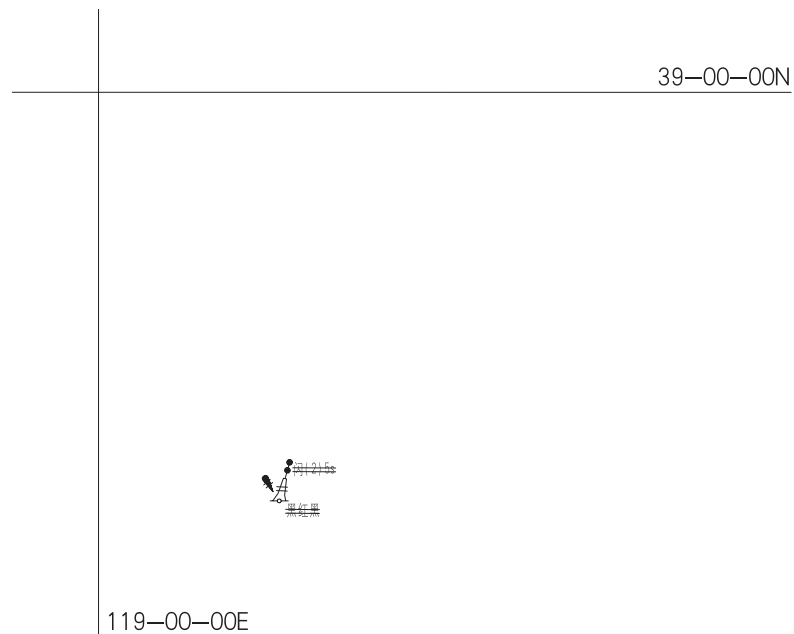

图号：1304	通告项号：2025 - 12
版时：2017.03	前次项号：2024 - 1329





图号：44001	通告项号：2025 - 13
版时：2022.02	前次项号：2025 - 2

31-30-00N

40 =

121-45-00E



图号：44001	通告项号：2025 - 13
版时：2022.02	前次项号：2025 - 2

31-30-00N

46

121-45-00E



图号：44125	通告项号：2025-13
版时：2024.10	前次项号：2025-2

31-22-00N

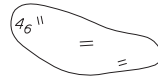

121-38-00E



图号：44174	通告项号：2025 - 13
版时：2019.05	前次项号：2025 - 2

121-40-00E

46

31-20-00N



图号：62631	通告项号：2025-14
版时：2015.03	前次项号：2024-1002

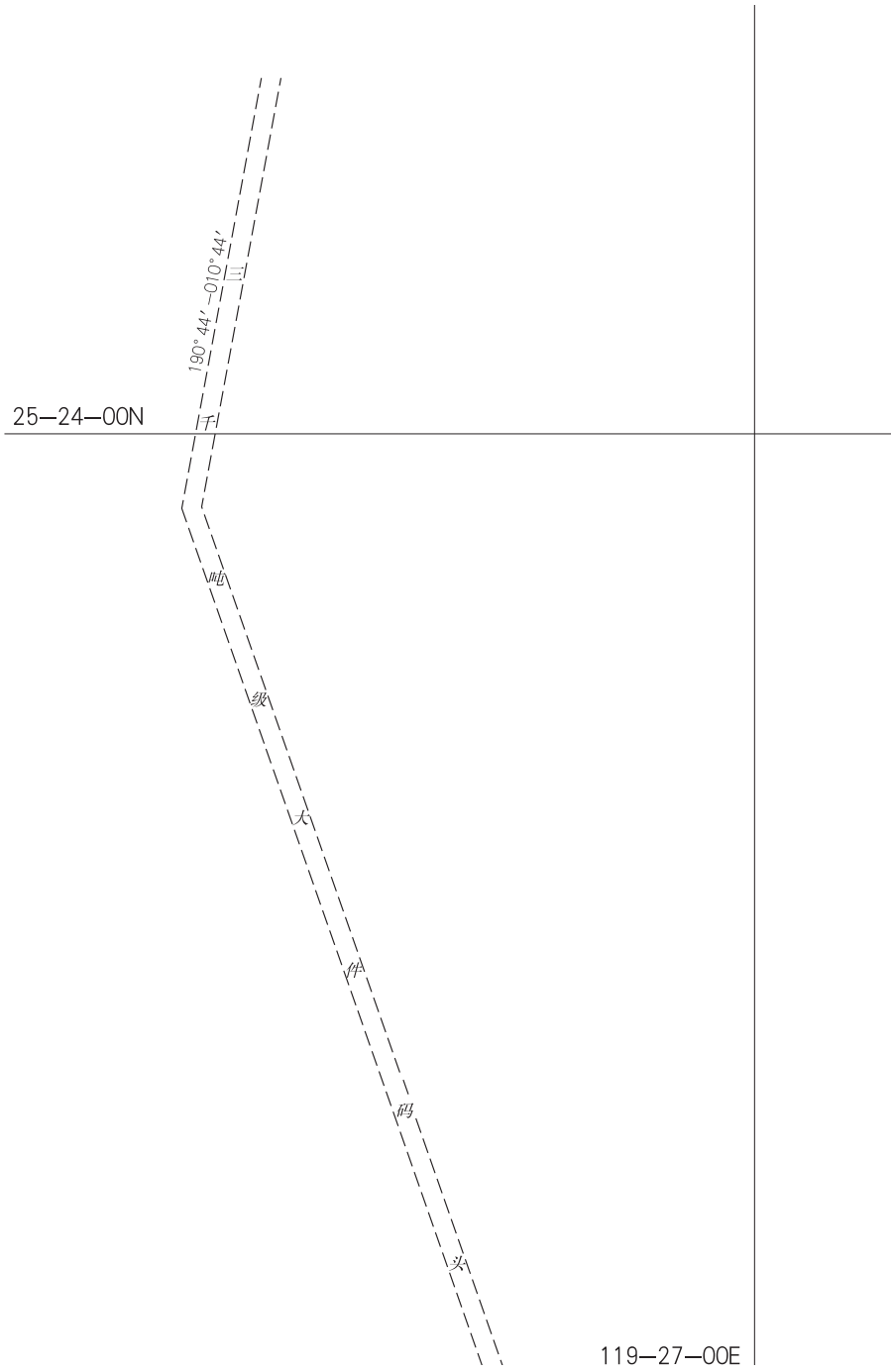



图号：62631	通告项号：2025-14
版时：2015.03	前次项号：2024-1002

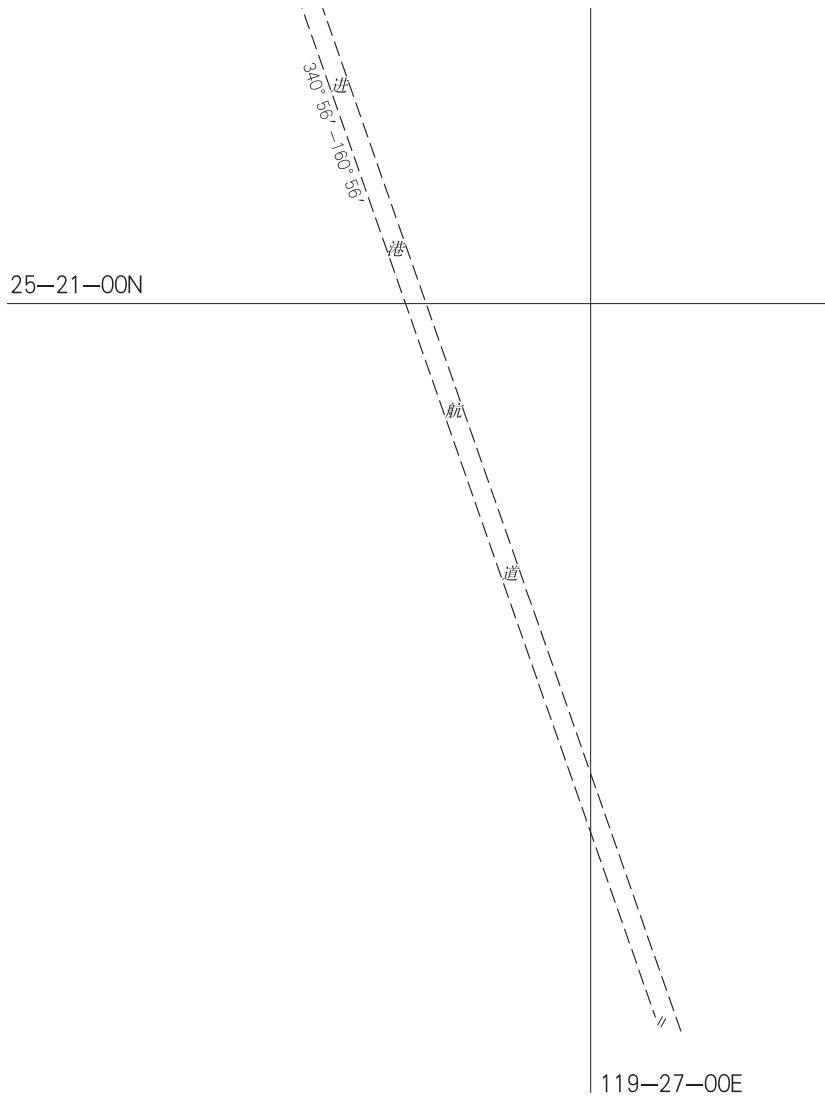



图号：62632	通告项号：2025-14
版时：2015.03	前次项号：2024-871

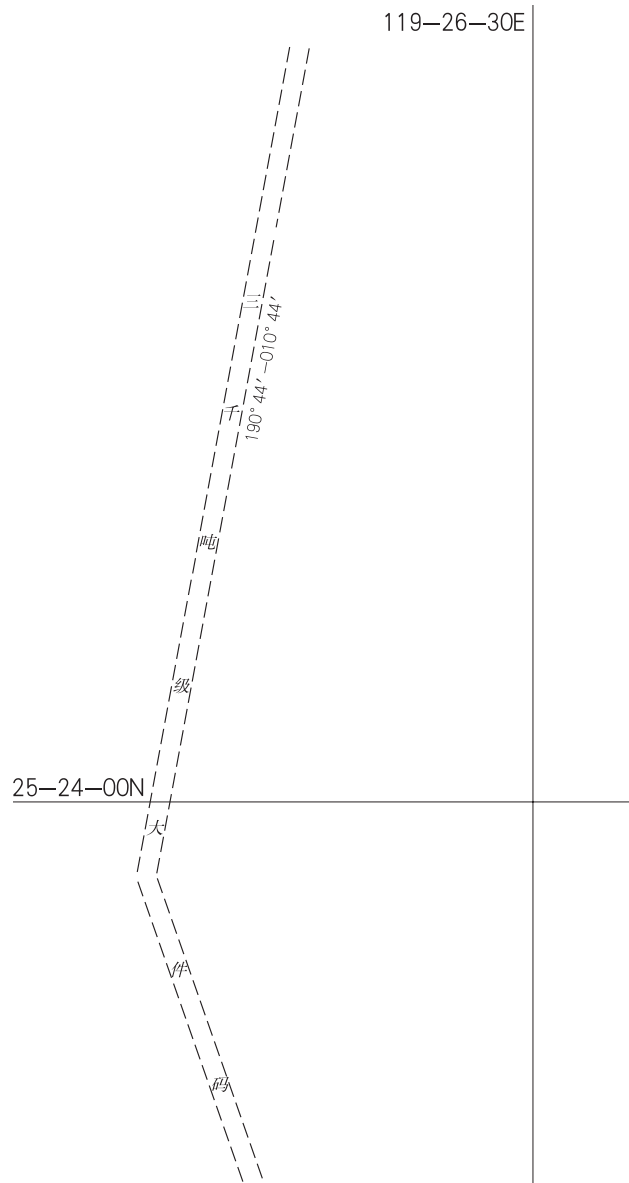



图号：62632	通告项号：2025-14
版时：2015.03	前次项号：2024-871

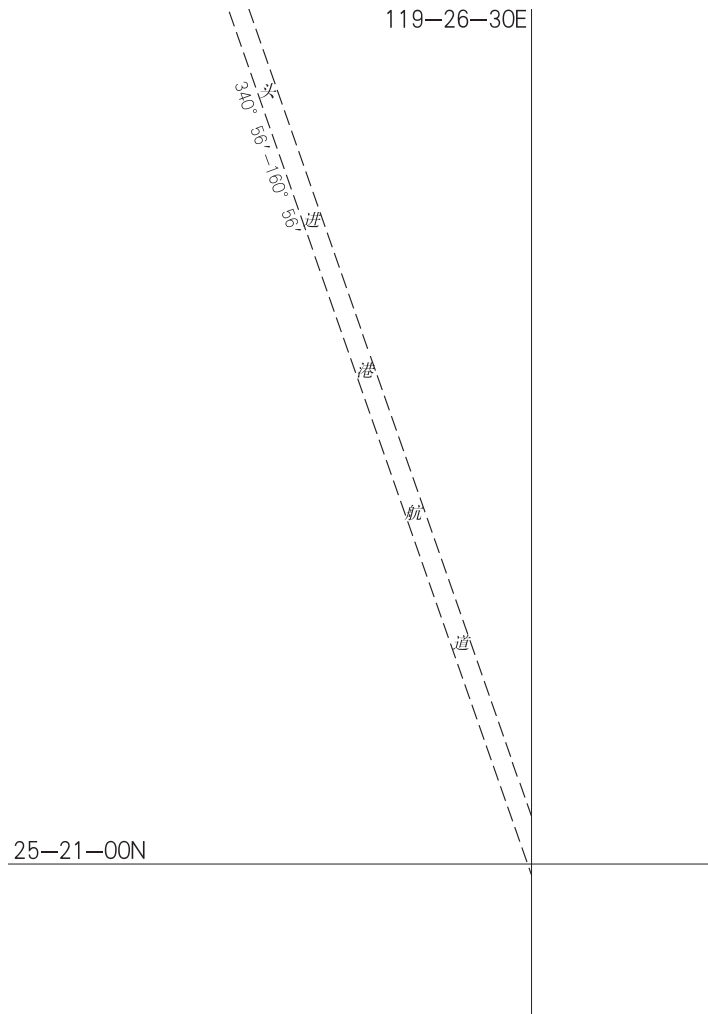



图号：62661	通告项号：2025 - 14
版时：2015.07	前次项号：2024 - 1002

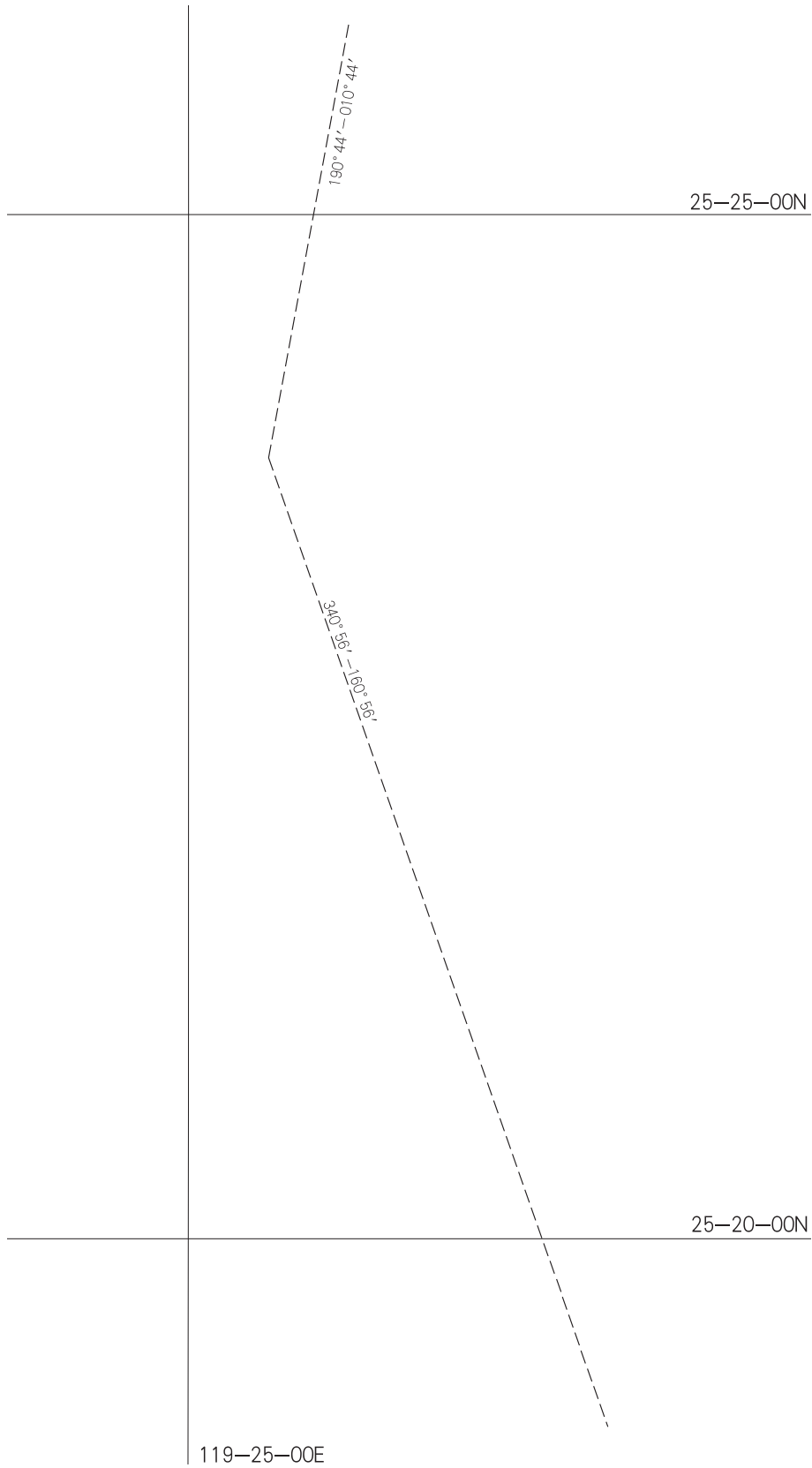



图号：63001	通告项号：2025-14
版时：2020.09	前次项号：2024-1231

25-30-00N

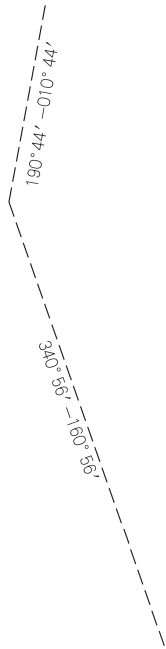

119-30-00E



图号：2311	通告项号：2025 - 15
版时：2012.10	前次项号：2024 - 1231

24-30-00N

44岩
36船
120-30-00E



图号：2312	通告项号：2025 - 16
版时：2012.10	前次项号：2024 - 1235

120-00-00E

40岩

23-30-00N



图号：2312	通告项号：2025 - 17
版时：2012.10	前次项号：2024 - 16





图号：81001	通告项号：2025 - 18
版时：2021.03	前次项号：2025 - 3

116-45-00E



23-00-00N





图号：81001	通告项号：2025-19
版时：2021.03	前次项号：2025-18

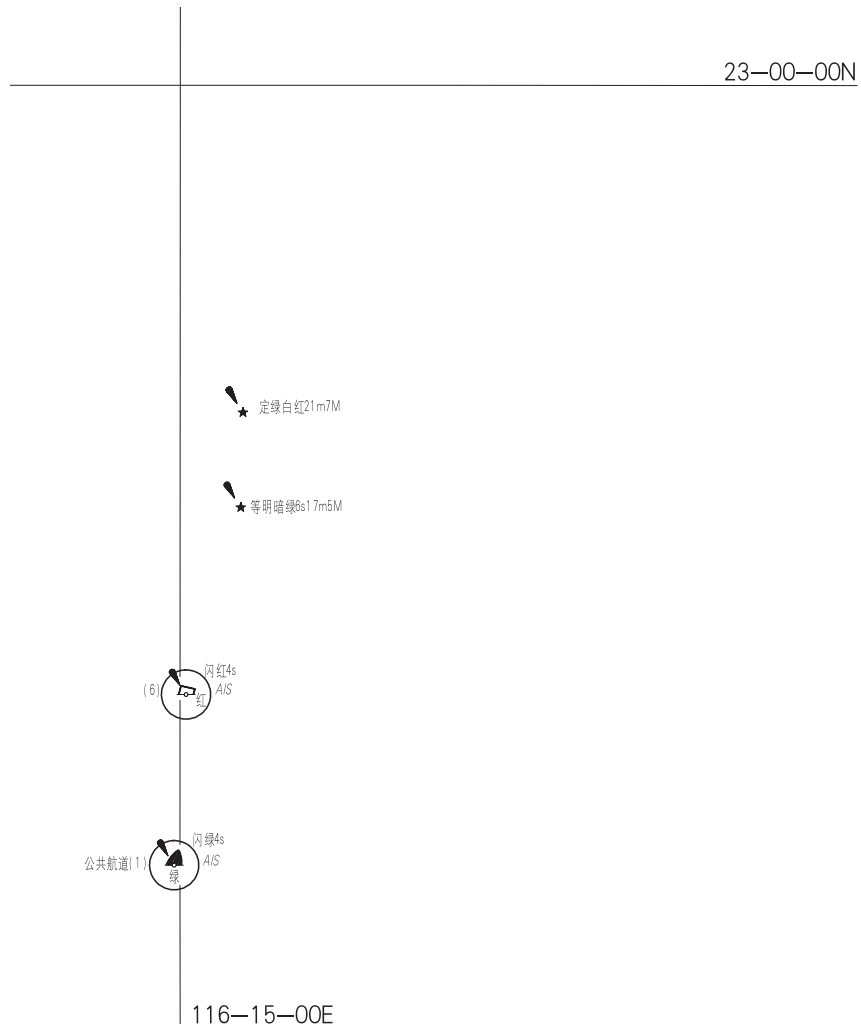



图号：81201	通告项号：2025 - 18
版时：2024.09	前次项号：2024 - 1151



图号：81301	通告项号：2025 - 18
版时：2023.12	前次项号：2024 - 1251

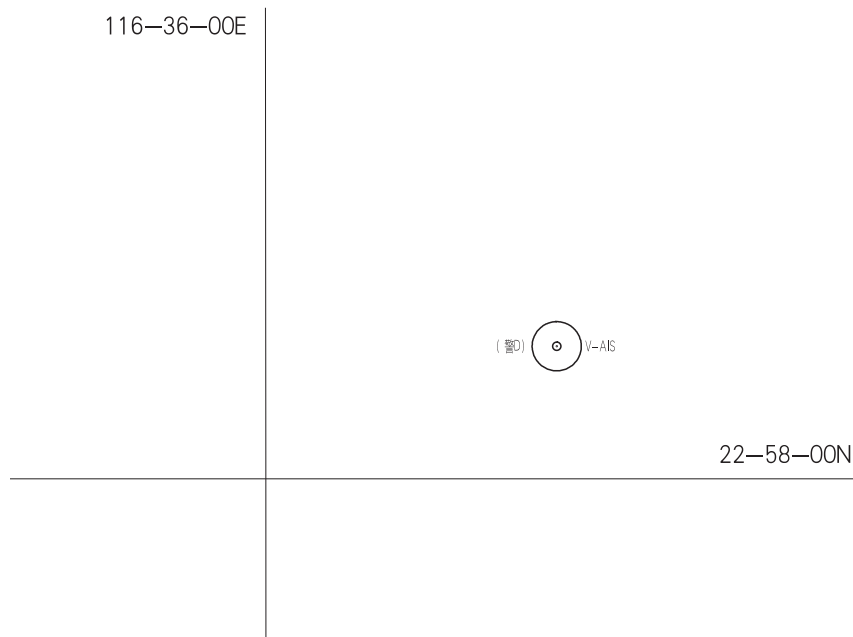



图号：81401	通告项号：2025-19
版时：2020.07	前次项号：2025-3

116-16-00E

★定绿白红21m7M

22-56-00N

★闪3s16m6M



图号：82001	通告项号：2025-19
版时：2024.11	前次项号：2025-3

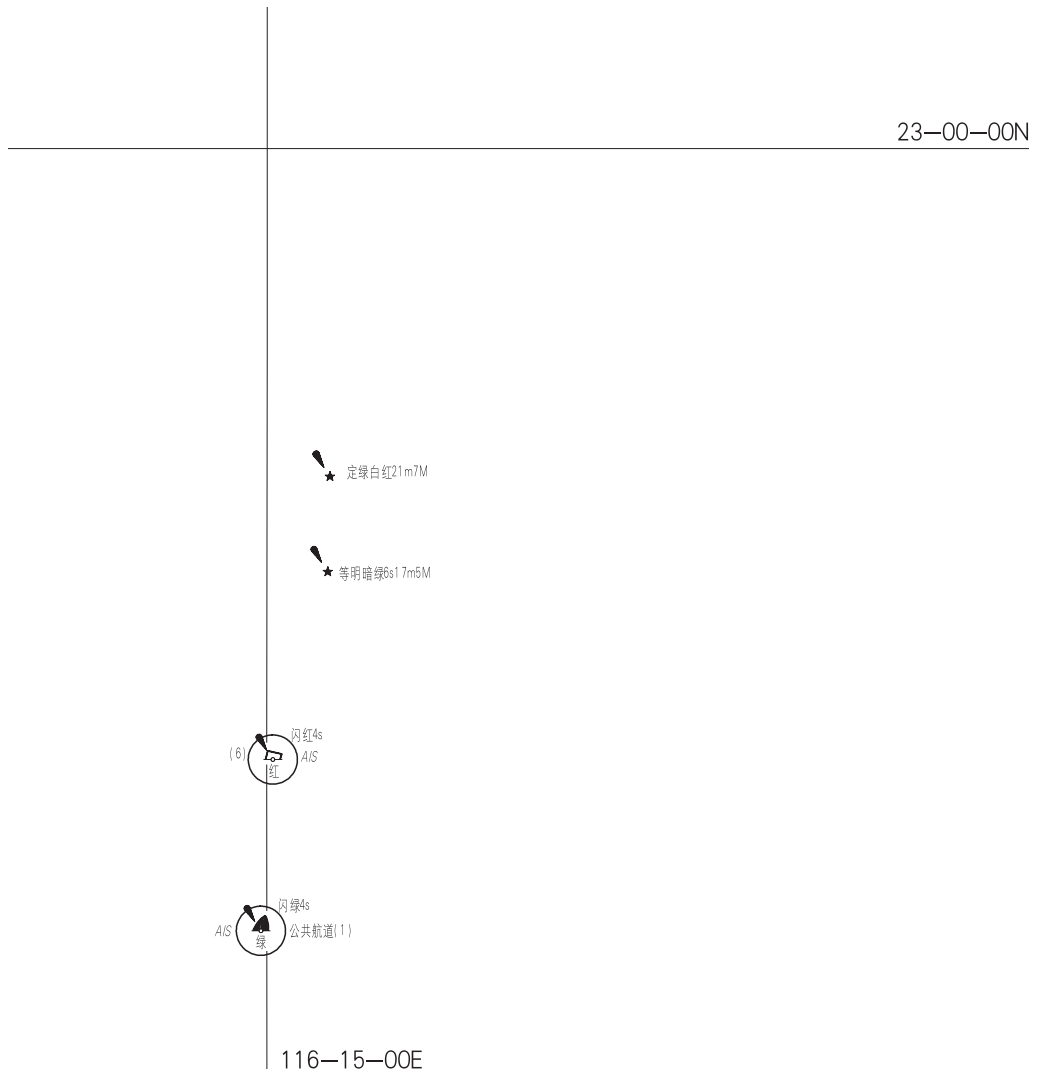



图号：83001	通告项号：2025 - 20
版时：2023.12	前次项号：2024 - 1348

115-00-00E

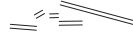

22-15-00N



图号：83001	通告项号：2025 - 21
版时：2023.12	前次项号：2025 - 20

22-15-00N



114-15-00E



图号：84001	通告项号：2025 - 21
版时：2015.03	前次项号：2024 - 1349

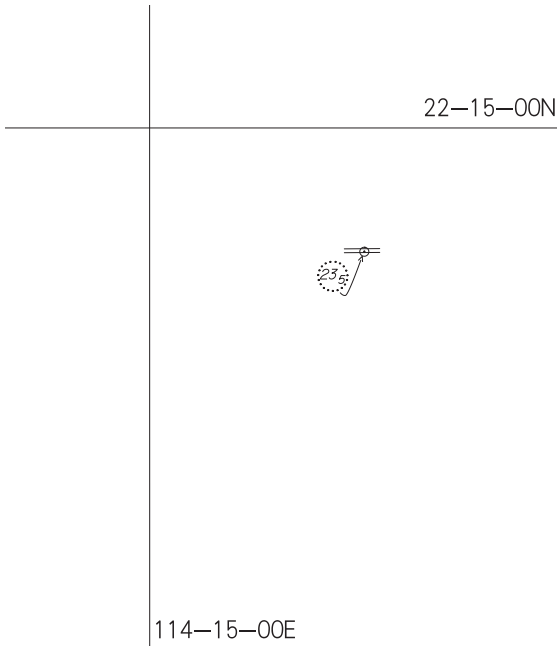



图号：84001	通告项号：2025-25
版时：2015.03	前次项号：2025-22

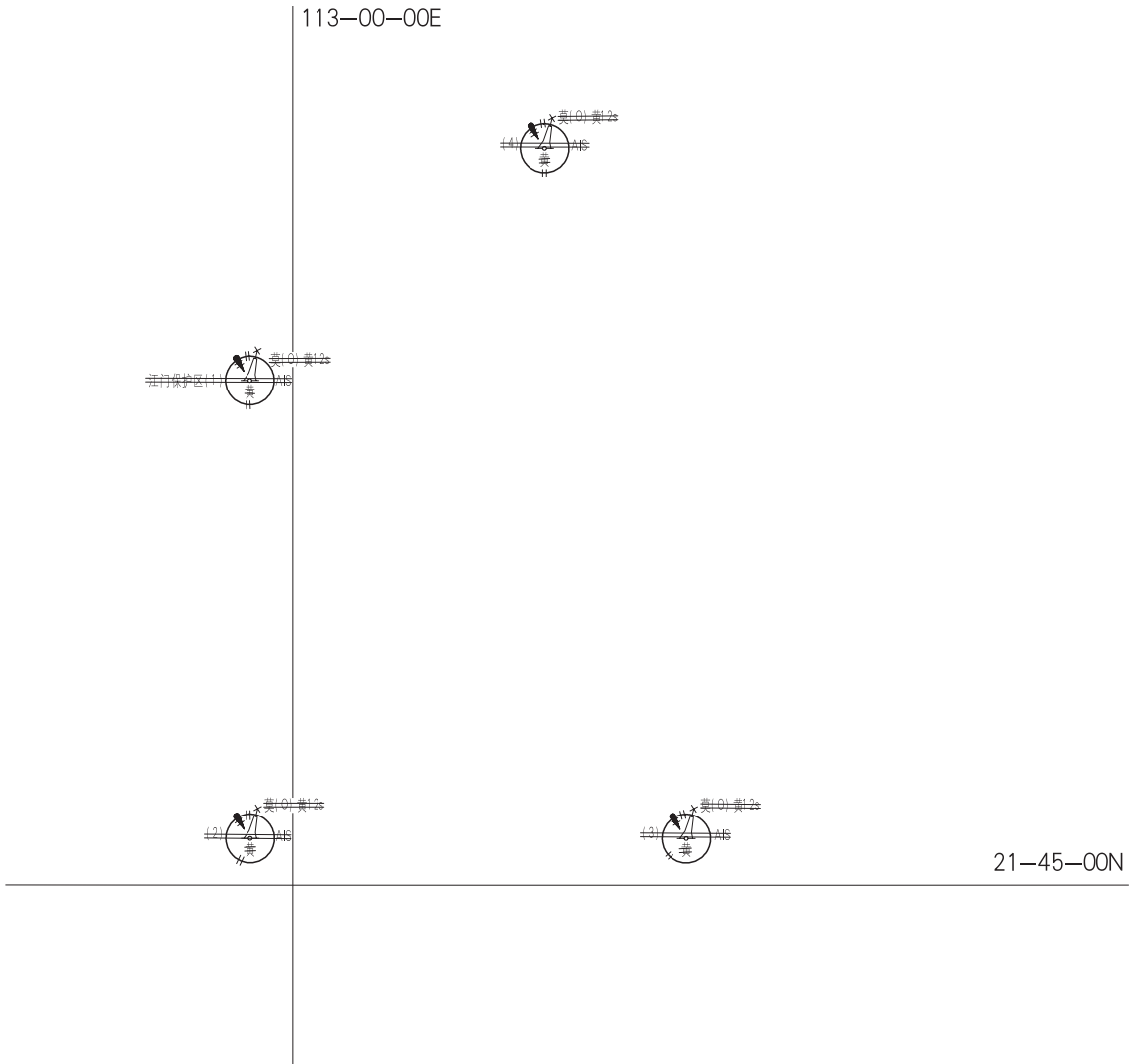



图号：84203	通告项号：2025 - 21
版时：2021.03	前次项号：2024 - 1348

22-13-59N



114-20-00E



图号：84204	通告项号：2025 - 24
版时：2024.09	前次项号：2024 - 1350

113-35-00E



22-10-00N



图号：84204	通告项号：2025 - 25
版时：2024.09	前次项号：2025 - 24

113-00-00E

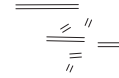
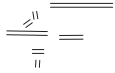

21-45-00N



图号：84204	通告项号：2025 - 25
版时：2024.09	前次项号：2025 - 24

113-00-00E

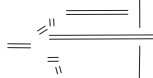
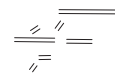

21-50-00N



图号：84206	通告项号：2025-24
版时：2024.10	前次项号：2025-4

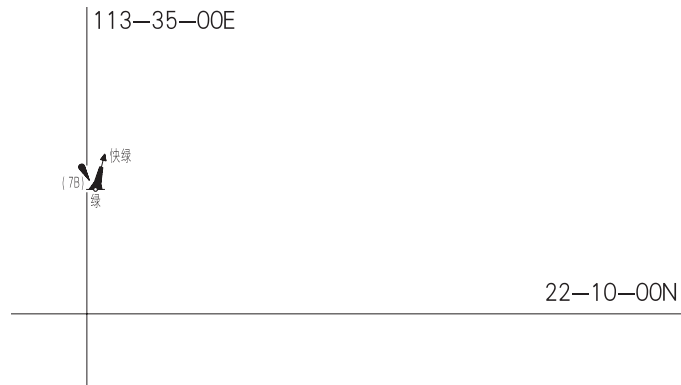

图号：84215	通告项号：2025-23
版时：2020.03	前次项号：2025-4





图号：84218	通告项号：2025 - 24
版时：2020.01	前次项号：2024 - 1350

113-36-00E



22-09-00N



图号：84221	通告项号：2025 - 24
版时：2024.09	前次项号：2024 - 1350

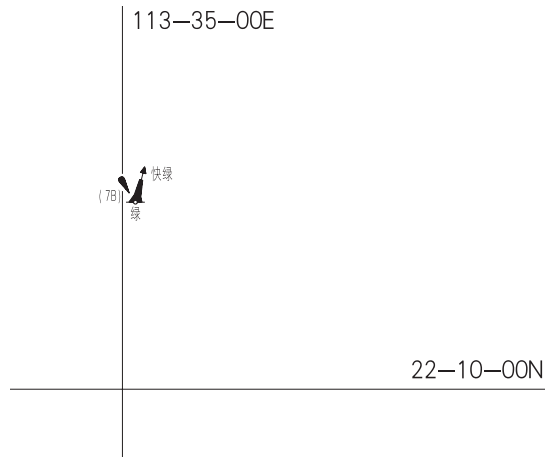

图号：85001	通告项号：2025 - 25
版时：2012.07	前次项号：2024 - 1353

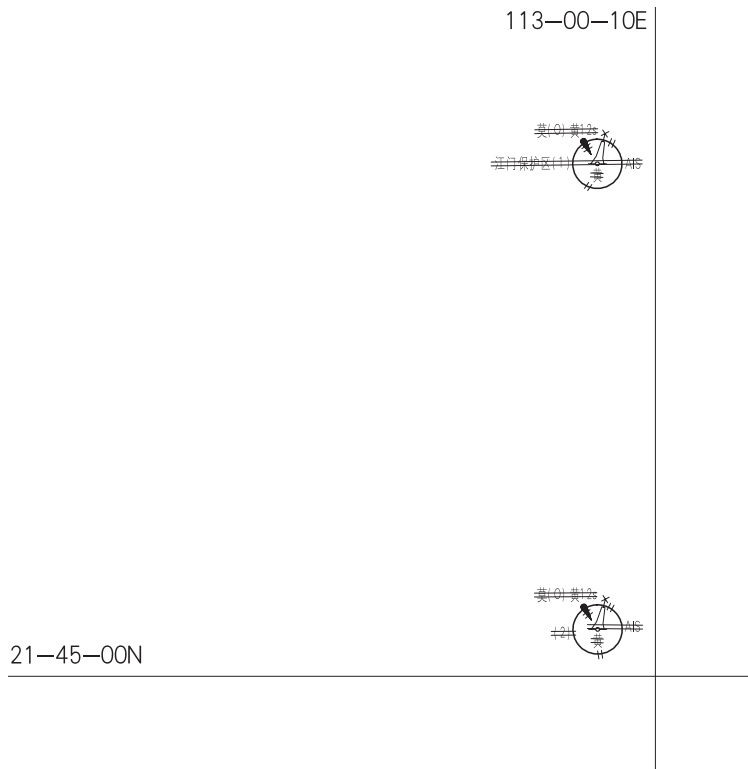



图号：85001	通告项号：2025-29
版时：2012.07	前次项号：2025-25

111-45-OOE

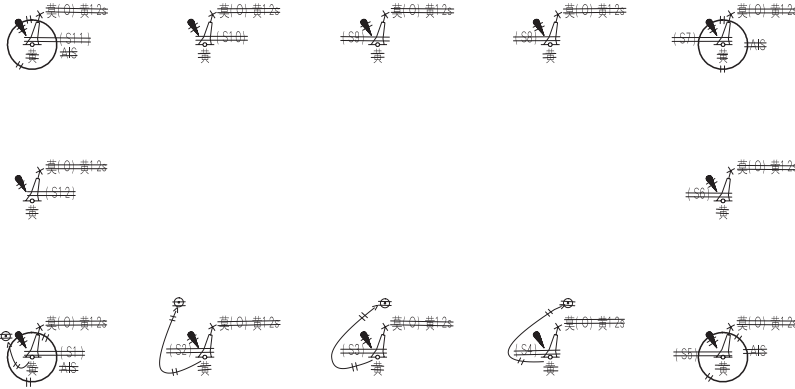

21-15-00N



图号：85101	通告项号：2025 - 25
版时：2023.08	前次项号：2024 - 1256

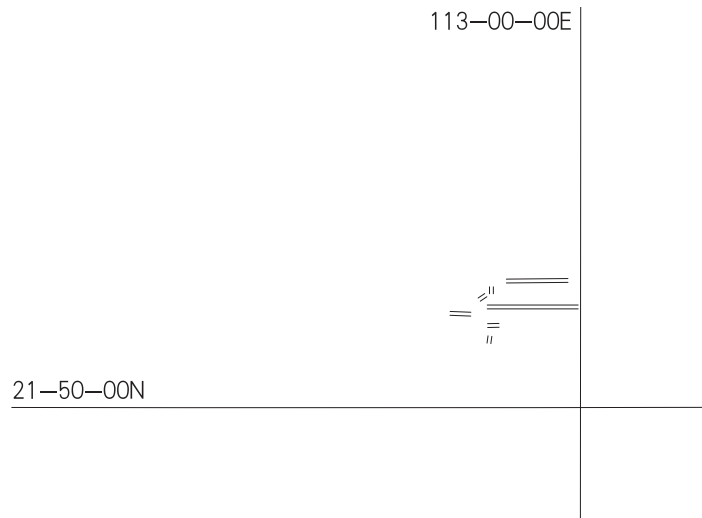

图号：85101	通告项号：2025 - 25
版时：2023.08	前次项号：2024 - 1256

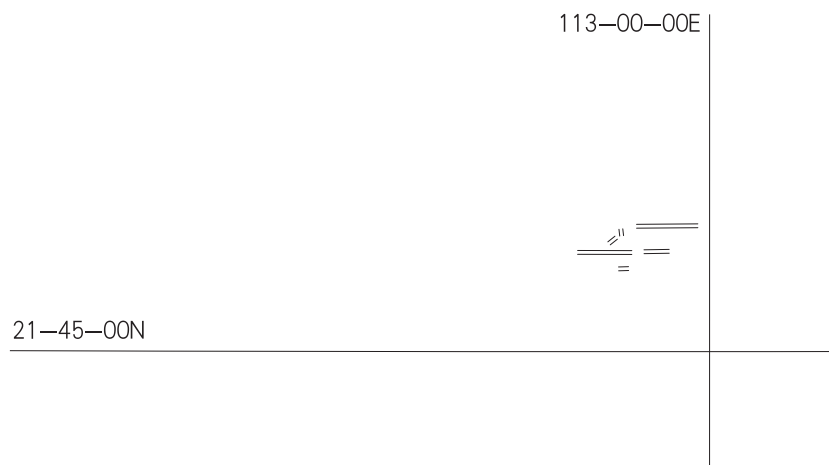



图号：85102	通告项号：2025 - 25
版时：2021.07	前次项号：2023 - 378

21-46-00N

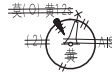

113-00-00E



图号：86101	通告项号：2025 - 28
版时：2024.09	前次项号：2024 - 1351

21-45-00N



111-45-00E



图号：86101	通告项号：2025-29
版时：2024.09	前次项号：2025-28

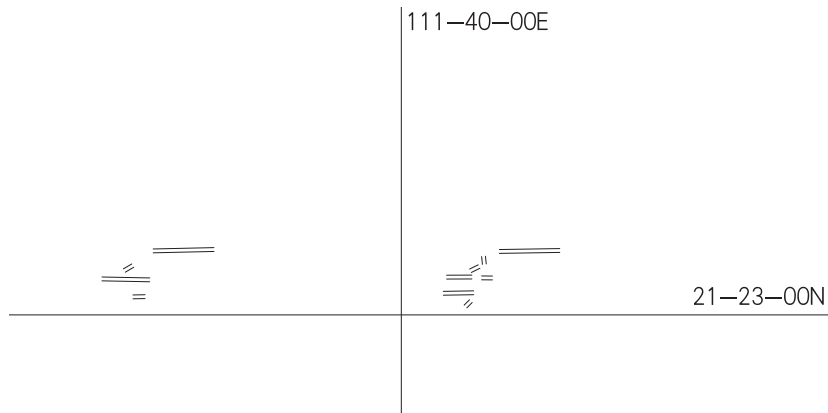

图号：86201	通告项号：2025-26
版时：2015.12	前次项号：2024-973

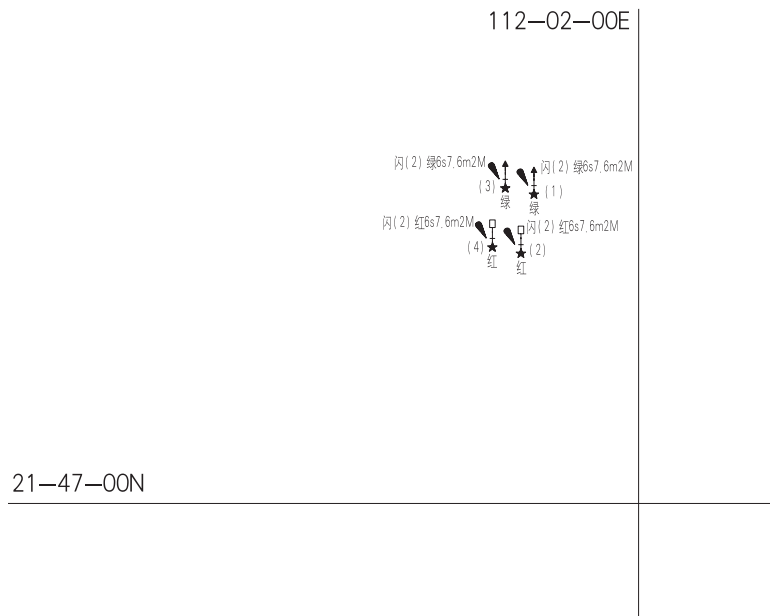



图号：86301	通告项号：2025 - 28
版时：2023.08	前次项号：2024 - 663

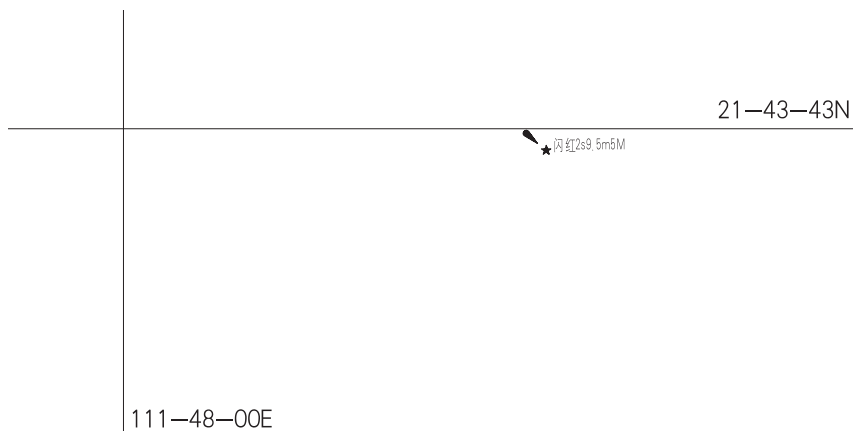

图号：86301	通告项号：2025 - 28
版时：2023.08	前次项号：2024 - 663

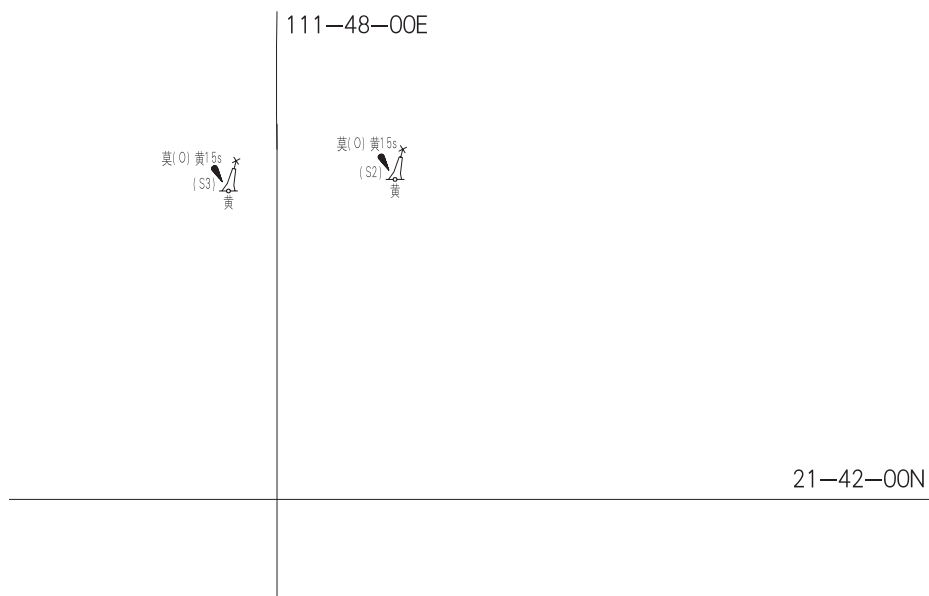



图号：87001	通告项号：2025 - 29
版时：2021.03	前次项号：2024 - 1353

111-30-00E



21-15-00N



图号：87102	通告项号：2025 - 30
版时：2024.03	前次项号：2024 - 1314

21-30-00N



111-15-00E



图号：88001	通告项号：2025 - 33
版时：2023.01	前次项号：2024 - 1264

20-30-00N

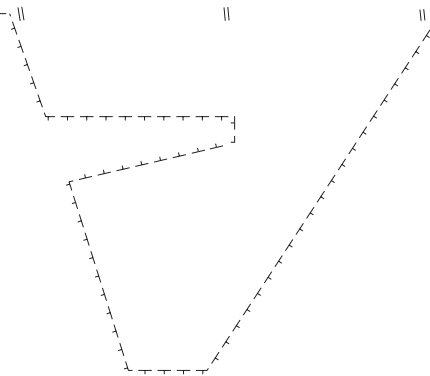

110-45-00E



图号：88101	通告项号：2025 - 31
版时：2024.03	前次项号：2024 - 1238

21-06-00N

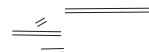
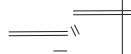
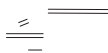
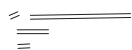

110-27-00E



图号：88101	通告项号：2025 - 31
版时：2024.03	前次项号：2024 - 1238

21-06-00N



110-27-00E



图号：88103	通告项号：2025-31
版时：2024.03	前次项号：2024-1238

21-06-00N

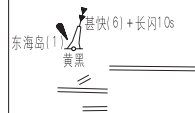
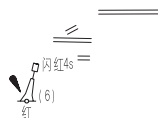
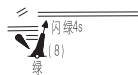

110-27-00E



图号：88103	通告项号：2025-32
版时：2024.03	前次项号：2025-31

110-24-00E



21-15-00N



图号：88105	通告项号：2025-31
版时：2024.01	前次项号：2024-1315

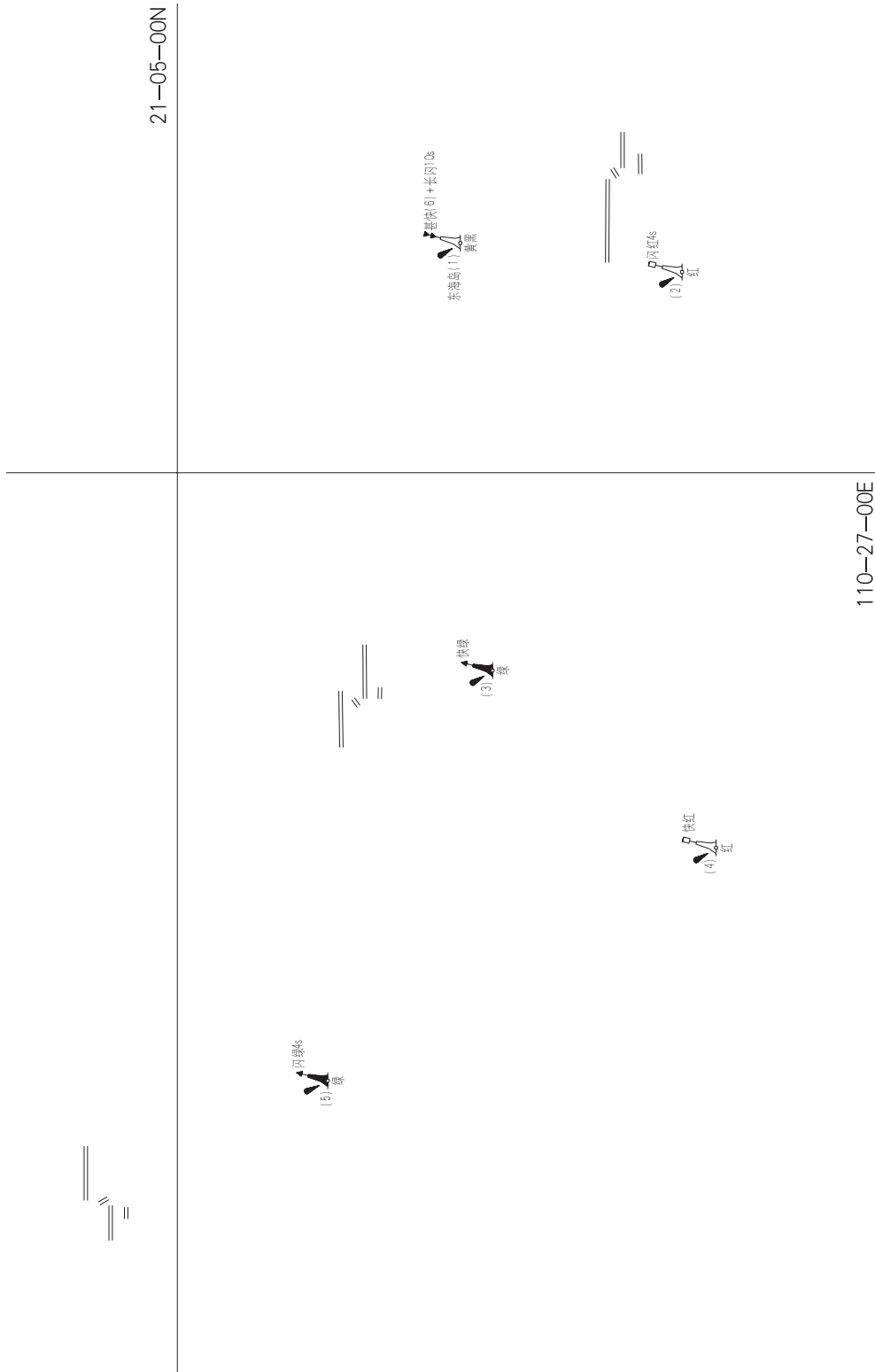



图号：88105	通告项号：2025-31
版时：2024.01	前次项号：2024-1315

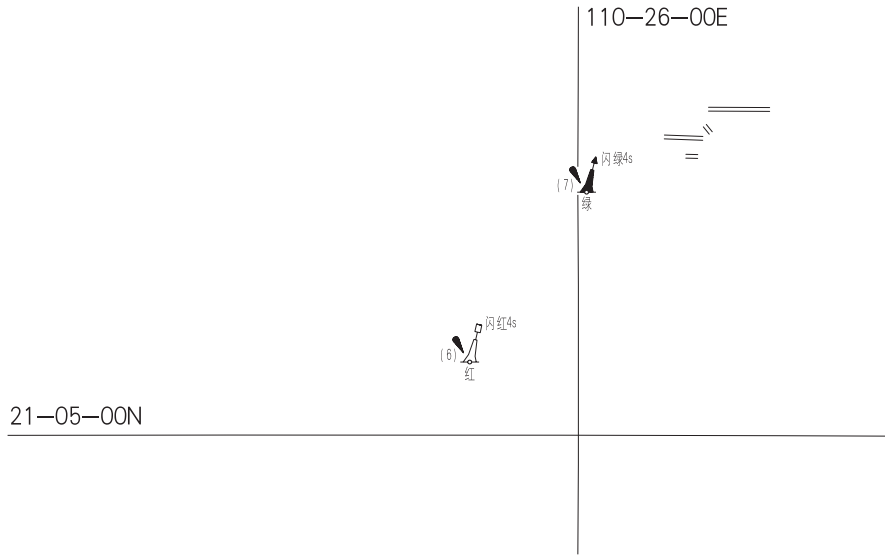

图号：88105	通告项号：2025-31
版时：2024.01	前次项号：2024-1315

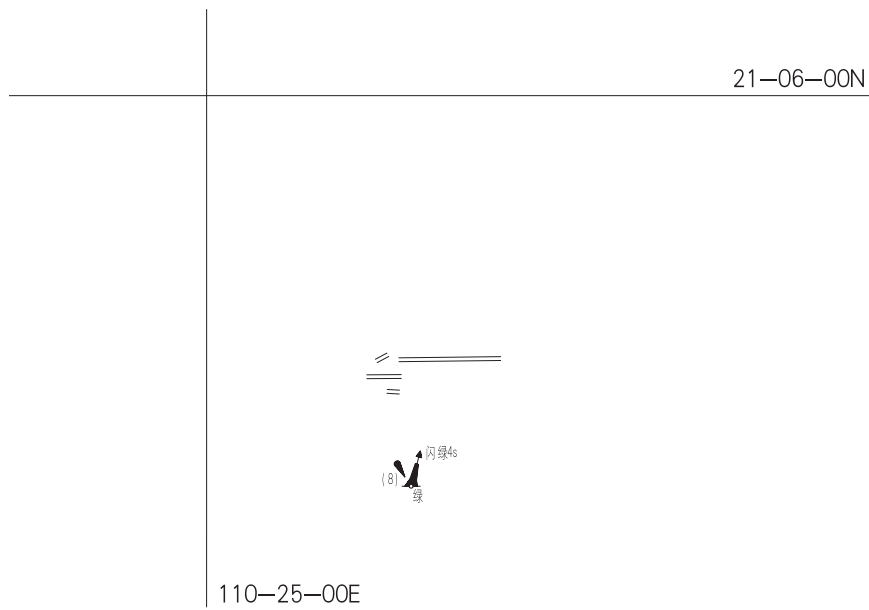



图号：88108	通告项号：2025 - 32
版时：2024.12	前次项号：2024 -

21-16-00N

湛江邮轮(1) 黄黑
甚快(6)+长闪10s

110-24-00E



图号：91204	通告项号：2025 - 34
版时：2020.03	前次项号：2024 - 1096

109-10-00E

21-25-00N

(7)★等明暗绿4s10m3M



图号：91301	通告项号：2025 - 34
版时：2023.10	前次项号：2024 - 1028

109-08-01E

(7)★等明暗绿4s10m3M

21-24-00N



图号：03002	通告项号：2025 - 35
版时：2012.06	前次项号：2024 - 1355

108-45-00E

闪绿4s
(W1) 绿
闪绿4s
乐东国电码头(0) 绿

18-30-00N



图号：03401	通告项号：2025 - 35
版时：2024.07	前次项号：2024 -

108-39-00E



18-32-00N



图号：03401	通告项号：2025 - 35
版时：2024.07	前次项号：2024 -

108-39-00E



18-31-00N



图号：04001	通告项号：2025 - 36
版时：2012.10	前次项号：2024 - 933

108-15-00E

概位 据报(2024)

19-15-00N



图号：3313	通告项号：2025 - 19
版时：2012.10	前次项号：2025 - 3

23-00-00N

定绿白红21m7M

116-30-00E



图号：3314	通告项号：2025-25
版时：2012.10	前次项号：2024-1346

22-00-00N

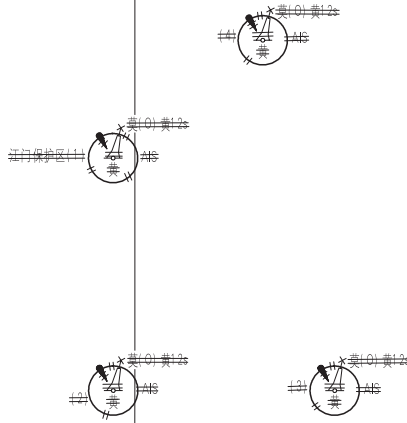

113-00-00E



图号：3314	通告项号：2025 - 27
版时：2012.10	前次项号：2025 - 25

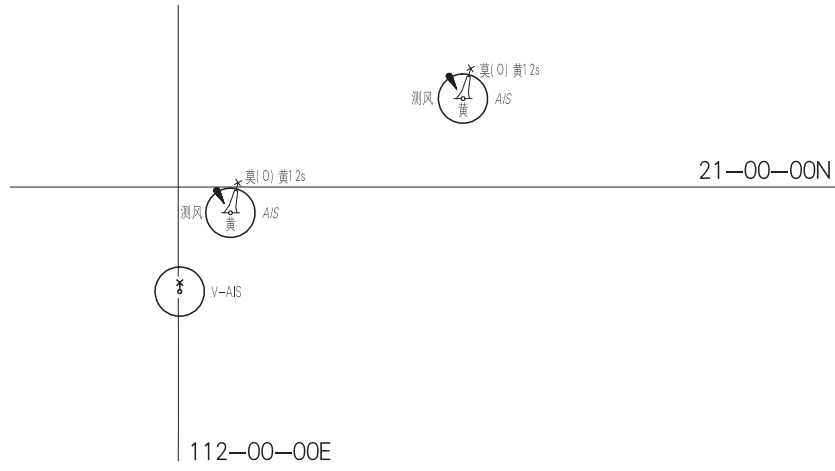

图号：3315	通告项号：2025 - 29
版时：2022.03	前次项号：2024 - 1353

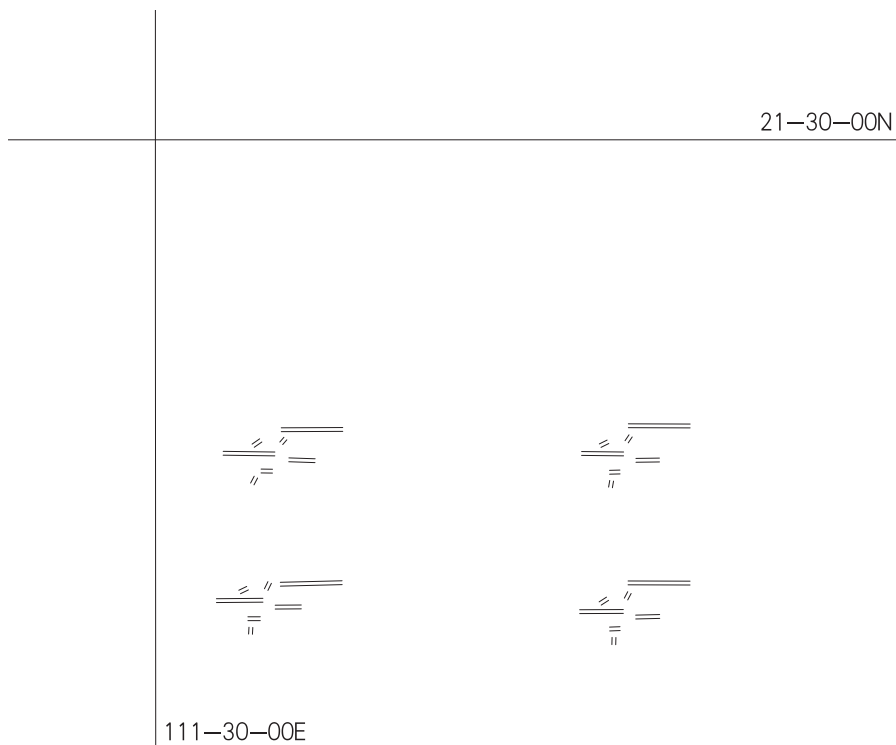



图号：3315	通告项号：2025-33
版时：2022.03	前次项号：2025-29

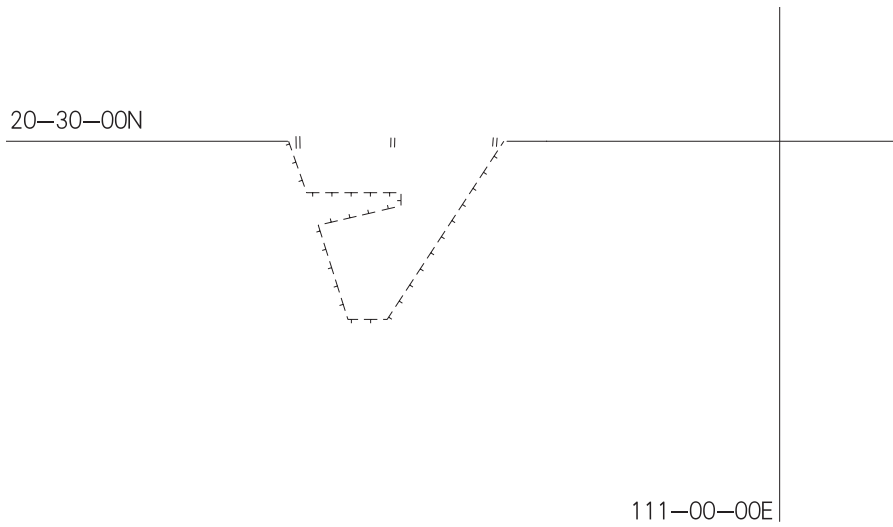

图号：3317	通告项号：2025-36
版时：2012.10	前次项号：2024-1355

